



Profit from the Eagle Advantage®

Specification Sheet

Short Form Specifications

Racks with Hanger Slots: Hanger slots on 2½" centers. Hanger bar suspended from 24"-wide wire shelf, 48" to 72" in length. Electropolished stainless or chrome plated finish.

Racks with Hooks: High density storage with hooks on 1½" centers staggered vertically for accessibility. 14"-wide by 48"-72" length. Chrome plated or electropolished stainless steel.

Racks with Hanger Tube: 1"-diameter tube suspended from an 18"-deep wire shelf 48"-72" in length. Chrome plated or brush stainless steel.

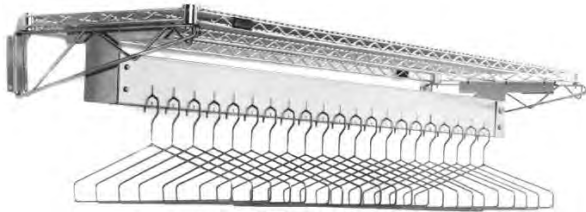

with hanger slots

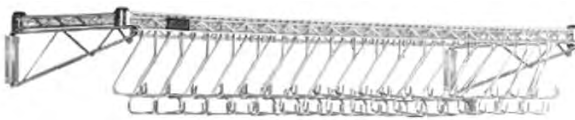

with hooks



with hanger tube

Options / Accessories

- Hangers
- Plastic shelf markers
- Keeper bars (for Racks with Hanger Slots)

Item No.:	_____
Project No.:	_____
S.I.S. No.:	_____

Wall Mounted Gowning Racks

MODELS:

- | | | |
|--------------------------------------|--------------------------------------|-------------------------------------|
| <input type="checkbox"/> EP2448-WGR | <input type="checkbox"/> EP1472-WGRH | <input type="checkbox"/> C1860-WGRT |
| <input type="checkbox"/> EP2460-WGR | <input type="checkbox"/> C1448-WGRH | <input type="checkbox"/> C1872-WGRT |
| <input type="checkbox"/> EP2472-WGR | <input type="checkbox"/> C1460-WGRH | <input type="checkbox"/> KB48-C |
| <input type="checkbox"/> C2448-WGR | <input type="checkbox"/> C1472-WGRH | <input type="checkbox"/> KB48-EP |
| <input type="checkbox"/> C2460-WGR | <input type="checkbox"/> S1848-WGRT | <input type="checkbox"/> KB60-C |
| <input type="checkbox"/> C2472-WGR | <input type="checkbox"/> S1860-WGRT | <input type="checkbox"/> KB60-EP |
| <input type="checkbox"/> EP1448-WGRH | <input type="checkbox"/> S1872-WGRT | <input type="checkbox"/> KB72-C |
| <input type="checkbox"/> EP1460-WGRH | <input type="checkbox"/> C1848-WGRT | <input type="checkbox"/> KB72-EP |

Design and Construction Features—all models

- Ideal for garment storage when floor space is not available.
- All units feature top wire shelf with patented QuadTruss® design (patent #5,390,803).
- Open-wire construction promotes laminar flow.
- Mounts easily to wall.

Racks with Hanger Slots

- Hanger bar constructed of heavy gauge type 304 stainless steel with hanger slots spaced on 2½" (64mm) centers.
- Available in chrome plated steel and electropolished stainless steel finish.
- Plastic shelf markers available.

Racks with Hooks

- Hooks, spaced on 1½" (38mm) centers, are staggered vertically for ease of access.
- All-welded construction.
- Available in chrome plated steel and electropolished stainless steel finish.

Racks with Hanger Tube

- 1" (25mm)-diameter full-length hanger tube, grooved at 1" (25mm) increments, is suspended on underside of wire shelf via two 2-gauge hooks, one on each end.
- Available in chrome plated and stainless steel finish.
- Plastic shelf markers available.

Distributed By: Custom Equipment Company
866-333-0728

Sales: sales@custommhs.com

General Info: info@custommhs.com

www.custommhs.com



Item No.: _____
 Project No.: _____
 S.I.S. No.: _____

Wall Mounted Gowning Racks

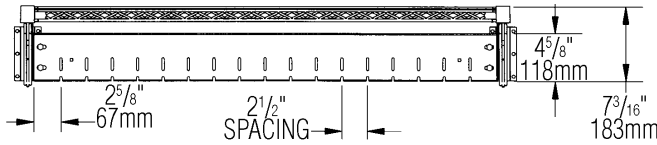
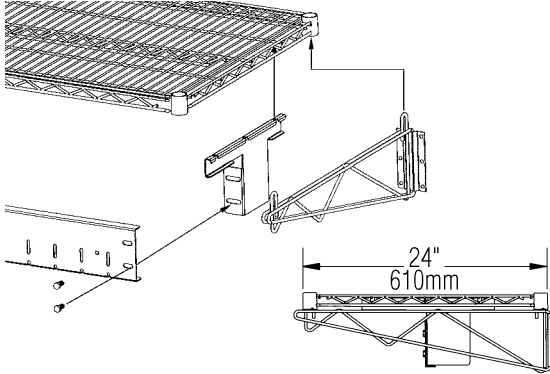

Racks with Hanger Slots

Hanger slots on 2 1/2" (64mm) centers. Optional hangers available.

electropolished		chrome		width		length		weight		number of hanger slots
model #	model #	in.	mm	in.	mm	lbs.	kg			
EP2448-WGR	C2448-WGR	24"	610	48"	1219	19	8.6	17		
EP2460-WGR	C2460-WGR	24"	610	60"	1524	24	10.9	22		
EP2472-WGR	C2472-WGR	24"	610	72"	1829	29	13.2	27		

Optional keeper bars for above racks

Makes hangers non-removable.

electropolished		chrome		length		number of hanger slots
model #	model #	in.	mm	in.	mm	
KB48-EP	KB48-C	48"	1219	17		
KB60-EP	KB70-C	60"	1524	22		
KB72-EP	KB72-C	72"	1829	27		

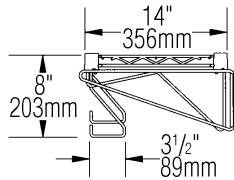

Racks with Hooks

All-welded construction. Hooks on 1 1/2" (38mm) centers.

electropolished		chrome		width		length		weight		number of hooks
model #	model #	in.	mm	in.	mm	lbs.	kg			
EP1448-WGRH	C1448-WGRH	14"	356	48"	1219	21	9.5	30		
EP1460-WGRH	C1460-WGRH	14"	356	60"	1524	27	12.2	38		
EP1472-WGRH	C1472-WGRH	14"	356	72"	1829	31	14.1	46		

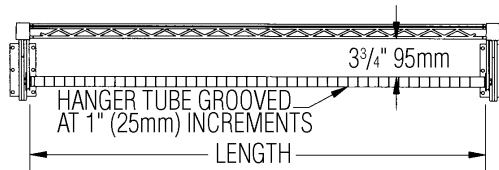
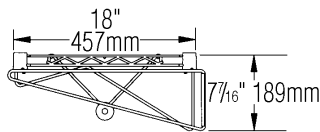
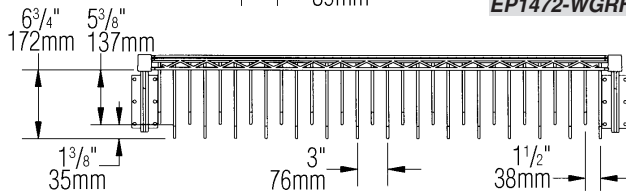

Racks with Hanger Tube

Replacement garment hanger tubes available.

stainless steel		chrome		width		length		weight	
model #	model #	in.	mm	in.	mm	lbs.	kg		
S1848-WGRT	C1848-WGRT	18"	457	48"	1219	17	7.7		
S1860-WGRT	C1860-WGRT	18"	457	60"	1524	22	10.0		
S1872-WGRT	C1872-WGRT	18"	457	72"	1829	27	12.2		

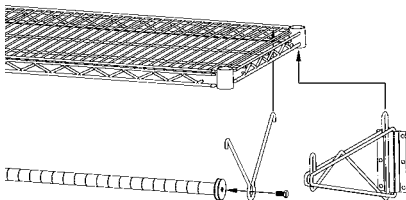

Distributed By: Custom Equipment Company

866-333-0728

Sales: sales@custommhs.com

General Info: info@custommhs.com

www.custommhs.com