

Work Center Plus Above Work Surface Structure



LC3011C

WORK CENTER PLUS ABOVE WORK SURFACE STRUCTURE

Whether you are installing a workbench for a production or assembly line, or a custom layout for your machine tool workshop, our line of products offers you an impressive selection of accessories that are sure to meet and surpass your expectations. From shipping and receiving, to your foreman's office, the quality and variety of our product will more than satisfy you.

Moreover, the Rousseau multi-purpose frame presents an immense advantage by being so easy to reconfigure, without tools. It can be changed according to your evolving needs by simply adding accessories.

Rousseau offers you several work surface dimensions for each of the surfaces offered: painted steel, stainless steel, laminated wood, laminated Acrylic/PVC, laminated and dissipative plastic tops. Rousseau, the one-stop solution to simplify your life!

Distributed by: Custom Equipment Company
 866-333-0728 sales@custommhs.com
 www.custommhs.com

Work Center Plus Above Work Surface Structure

The Rousseau Advantages

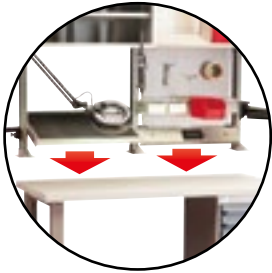

Rousseau will meet even your most specific workbench need, from top to bottom.



Re-configuring your workbench is easy and can be done without tools. This means your system will evolve with you and your needs.



Our impressive array of standard accessories allows you to build a custom bench.

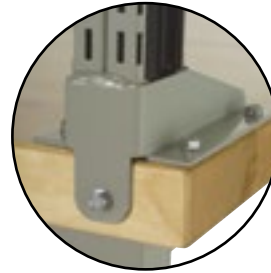

The WM structure can be installed on most industrial workbenches on the market. The six fixing zones mean limited interference and endless possibilities.

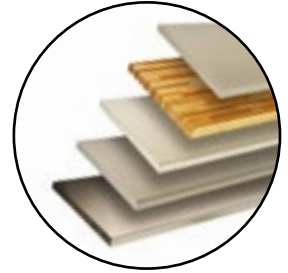

Choose from our different work surfaces for specific applications.

General Dimensions

Width x height above

Riser Shelves

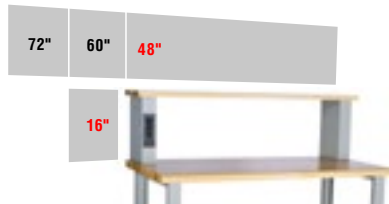

Multi-Purpose Uprights

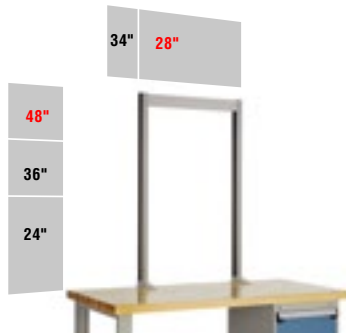
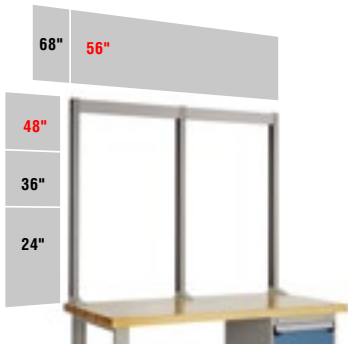

Index	Page(s)
Work Center Plus Above Work Surface Structure	116 - 117
Proposals	118 - 122
Components	
– Structure Above the Work Surface	123 - 133



WSC2018



LC6003



LC3125C

Basic Workstation

WSC0133

Better organization with the help of Rousseau accessories.



WSC0133

1 WM single unit frame	WM11-2848
2 tiltable shelves	WM20-2812
2 plastic bin rails	WM28-2801
1 vertical adaptor for electrical and air outlets	WM41-01
1 power outlet strip	70000505
6 partial dividers	SH52-1206
5 plastic bins	RG20-040303
2 open legs	WS20-2732
1 stringer	WS22-6005
1 painted steel top	WS10-6030

Product #	W x D x H
WSC0133	60" x 30" x 80"

Packaging Station

WSM0006

All the right accessories for a packaging station, with a spool support under the table.



WSM0006

2 multi-purpose uprights	WM10-48
2 steel shelves	WS50-6012
2 structural shelf supports	WM27-1201
6 sliding dividers	WS87-1210
1 vertical adaptor for electrical and air outlets	WM41-01
1 power strip	70000505
1 document holder with arm	WM70-01
2 open legs	WS20-2732
1 stringer	WS22-6005

1 laminated hardwood top	WS14-6030A
1 paper and cardboard spool support	WS86-60
2 leg crossbars	WS24-27

Product #	W x D x H
WSM0006	60" x 30" x 80"

SOLD SEPARATELY

Packaging shear cutter

WM87-01

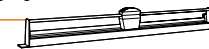

SEE PAGE 113

End-of-Aisle Workstation

WSM0017

Perfect for consulting information close to stored materials.

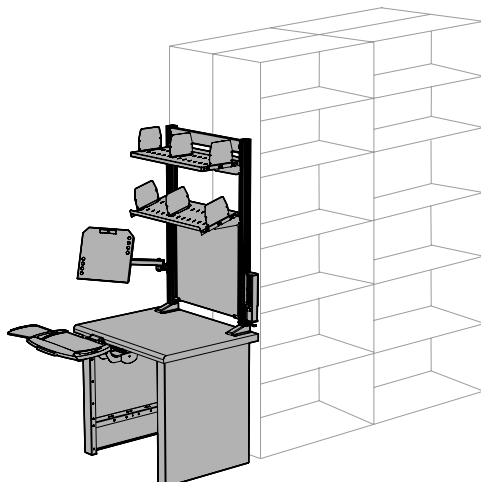

WSM0017

2 closed legs	WS25-2732
1 laminated hardwood top	WS14-3630A
1 WS90-01 sliding keyboard tray or WS90-02 adjustable keyboard tray (except on WSM0018 model without keyboard tray)	
1 single unit frame	WM11-2848
2 tiltable shelves	WM20-2812
6 partial dividers	SH52-1206
1 power strip	70000505
1 vertical adaptor for electrical and outlets	WM41-01
1 document holder with arm	WM70-01
1 tackboard / marker panel	WM54-2424
1 panel bracket kit	WM50-01

Product #	Type of Keyboard Tray	W x D x H
WSM0016	WS90-01 sliding tray	36" x 30" x 80"
WSM0017	WS90-02 adjustable tray	36" x 30" x 80"
WSM0018	Model without tray	36" x 30" x 80"

Components – Structure Above the Work Surface

Multi-Purpose Frame Components

Multi-Purpose Upright

WM10

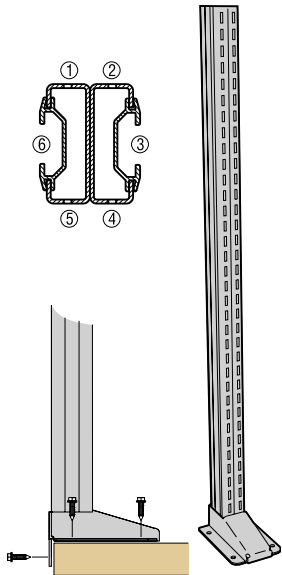

May be installed on most workbench tops offered on the market. Requires a good quality top, at least 1 1/2" thick;

Characterized by its shape and rigidity; Offers up to six fixing zones for a minimum of interference between components;

Perforated on front and back faces at 1" c/c intervals for optimum adjustment of accessories ①②④⑤;

Features two black aluminum extrusions on the sides for infinitely adjustable accessories ③⑥;

Five anchor points on the foot ensure stability on the two main axes;

Symmetrical shape means the upright may be used for back-to-back workstations;

The 48" height is ideal for overhead accessories.

Product #	Height
WM10-24	24"
WM10-36	36"
WM10-48	48"

WM Unit Frame

WM11

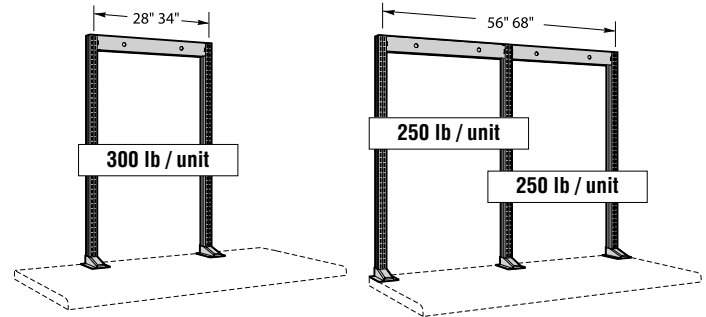

The single unit frame consists of:

- 2 WM10 uprights
- 1 WM15 upright cross member

Capacity : 300 lb. per unit frame.

The double unit frame consists of:

- 3 WM10 uprights
- 2 WM15 upright cross members

Capacity : 250 lb. per unit frame (Total : 500 lb.).

Product #	W x H	W Required
WM11-2836	28" x 36"	36" min.
WM11-2848	28" x 48"	36" min.
WM11-3436	34" x 36"	48" min.
WM11-3448	34" x 48"	48" min.

Product #	W x H	W Required
WM11-5636	56" x 36"	60" min.
WM11-5648	56" x 48"	60" min.
WM11-6836	68" x 36"	72" min.
WM11-6848	68" x 48"	72" min.

Top Flange for WM11 Frame - 28" c/c

WS18 / WS98

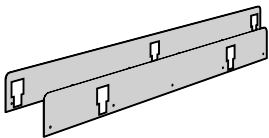

Painted steel : WS18;

Stainless steel : WS98;

Designed specifically to be compatible with the WM11 frame of 28" single or double;

Installs on all types of tops;

Height : 5". Exceeds top by approx. 3 1/4";

Designed for an upright that is centered on the workstation;

Specify type of steel to place order. Ex.: WS18-480502 for a top flange in painted steel for a WM11 frame measuring 28" wide with 2 uprights.

Product #	Width	Application
WS__-360502	36"	For 2 WM uprights
WS__-480502	48"	For 2 WM uprights
WS__-600502	60"	For 2 WM uprights
WS__-600503	60"	For 3 WM uprights
WS__-720502	72"	For 2 WM uprights
WS__-720503	72"	For 3 WM uprights

Top Flange for WM11 Frame - 34" c/c

WS1A / WS91

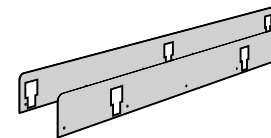

Top flange in painted steel : WS1A;

Top flange in stainless steel : WS91;

Designed specifically to be compatible with the WM11 frame measuring 34" single or double;

Installs on all types of tops;

Height : 5". Exceeds top by approx. 3 1/4";

Designed for an upright that is centered on the workstation.

Specify the type of steel to place order. Ex.: WS1A-480502 for a top flange in painted steel for a WM11 frame measuring 34" wide with 2 uprights.

Product #	Width	Application
WS__-480502	48"	For 2 WM uprights
WS__-600502	60"	For 2 WM uprights
WS__-720502	72"	For 2 WM uprights
WS__-720503	72"	For 3 WM uprights

Upright Cross Member

WM15

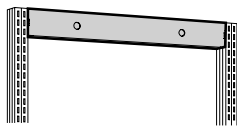

Strengthens unit frames;

Hooks onto WM10 uprights and can be secured in place;

Includes two knockouts for pneumatic connectors.

Product #	Width (c/c)
WM15-28	28"
WM15-34	34"
WM15-56	56"
WM15-68	68"

Cantilever Overhead Supports

WM18

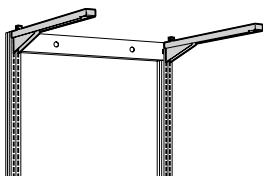

Sold in pairs;

Clip onto WM10 uprights;

Lock in place with a safety latch located on the top of the support;

Capacity : are designed to hold a WM45/WM43 overhead workstation light and one WM47 tool rail, or two WM47 tool rails.

Product #	Depth	Color
WM18-26	26"	Black

Top Reinforcer

WM14

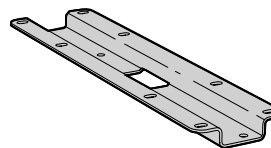

Required for work tops less than 1 1/2" thick, in poor condition or back-to-back workstations; Used to strengthen the anchor points of the WM10 upright;

Fastened to the underside of the work surface.

Product #	W x D	Color
WM14-01	4" x 16"	Black

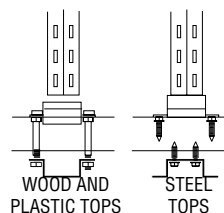

Recommended with work tops other than Rousseau's.

Components – Structure Above the Work Surface

Shelf

WS50 / 51 / 52 / 53 / 56 / 57



Installed on WM10 uprights with WM27 shelf supports;
Capacity : 200 lb.;
Possible to add WS58 or WS99 shelf back or front stop;
Thickness : 1 1/4".

Product #	W x D	Type of Shelf
WS50-6012	56 3/4" x 12"	Steel
WS51-6012	60" x 12"	Laminated wood
WS52-6012	60" x 12"	Plastic laminated
WS53-6012	60" x 12"	Dissipative
WS56-6012	56 3/4" x 12"	Stainless steel
WS57-6012	60" x 12"	Acrylic/PVC laminated
WS50-7212	68 3/4" x 12"	Steel
WS51-7212	72" x 12"	Laminated wood
WS52-7212	72" x 12"	Plastic laminated
WS53-7212	72" x 12"	Dissipative
WS56-7212	68 3/4" x 12"	Stainless steel
WS57-7212	72" x 12"	Acrylic/PVC laminated

Sliding Divider

WS87

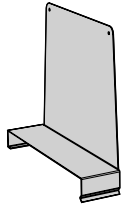

Clips onto a 12" deep WS50 steel shelf installed above or below the work surface;
Not compatible for use with WS58 shelf with a back or front stop.

Product #	D x H
WS87-1210	12" x 10"

Tiltable Shelf

WM20

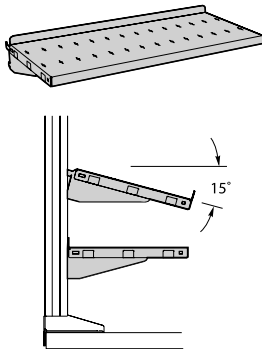

Clips onto WM10 uprights;
Slotted to receive SH52 dividers at every 2" c/c;
Includes 2 side supports that may be placed at right angles or at an angle of 15°;
Shelf is reversible and the edge can be used as a back stop or support for plastic bins or for ring binders with a 12" deep shelf;
Capacity : 100 lb., evenly distributed load.

Product #	W x D
WM20-2808	28" x 8"
WM20-2812	28" x 12"
WM20-3408	34" x 8"
WM20-3412	34" x 12"

Partial Divider

PATENTED

SH52

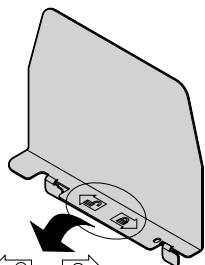

Unique patented divider;
May be used with WM20 8" and 12" deep shelves; adjustable every 2" c/c;
Installed in the shelf slots, forward or backward.

Product #	D x H
SH52-1206	8" x 6"

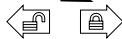

Pictograms to facilitate installation

Structural Shelf Supports

WM27

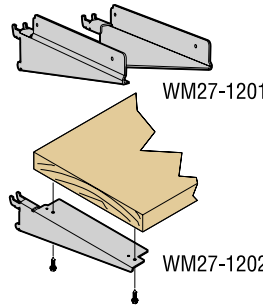

Sold in pairs;
Clip onto WM10 uprights;
Used with all types of 48", 60" or 72" wide shelves;
May be positioned at a right angle or inclined at an angle at 15°.

Product #	Depth	for Shelves
WM27-1201	12"	WS50, WS56
WM27-1202	12"	WS51, WS52, WS53, WS57

Tiltable Pan

WM22

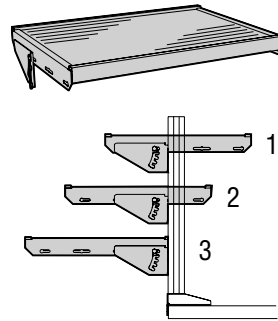

Clips onto WM10 uprights;
Three positions: front, center and back;
Unique feature: may be easily tilted from 0 to 30° with 5 adjustment positions;
Full-size ribbed matting included;
Usable space : 24 1/2" x 18 1/2" (28" x 20");
Usable space : 30 1/2" x 18 1/2" (34" x 20");
Capacity : 200 lb.

Product #	W x D
WM22-2820	28" x 20"
WM22-3420	34" x 20"

Tool Support

WM30

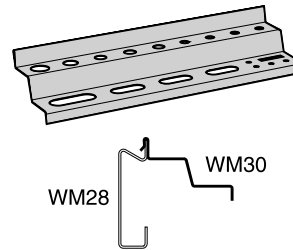

Made of galvanized steel;
Installs on WM20 shelf, WM28 plastic bin rail or on WM62 monitor tray;
Features holes of several sizes to hang tools.

Product #	Width
WM30-01	12"

Paper and Cardboard Spool Support

WM86

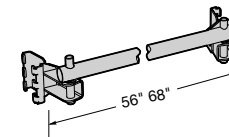

Installs on WM10 uprights to create a packaging station;
Includes two end brackets and one rod;
Rod diameter : 1";
One person alone may insert the spool by pivoting one end of the rod;
Color : Black;
Capacity : 75 lb.

Product #	Width
WM86-56	56"
WM86-68	68"

Wire Spool Support

WM31

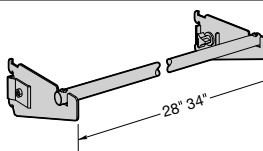

Includes 2 side supports and a 3/4" diameter rod;
Capacity : 50 lb.

Product #	Width
WM31-2801	28"
WM31-3401	34"

Components – Structure Above the Work Surface

Plastic Bin Rail

WM28



Clips onto the WM10 uprights; adjustment every 1" c/c;
Can be installed at a right angle or angled 15°;
Suited to all makes of plastic bins with hanger lip sold on the market;
Can receive all sizes of RG20 plastic bins;
Capacity : 75 lb., evenly distributed load.

Product #	Width
WM28-2801	28"
WM28-3401	34"

Tool Rail

WM47

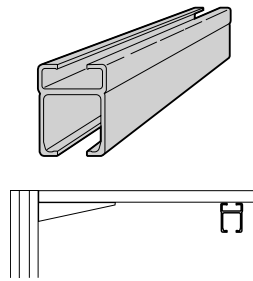

Allows the installation of one or more WM48 balancer trolley;
Installs on WM18 cantilever overhead supports (sold separately);
Easily adjustable depth;
Color : Black;
Capacity : 25 lb.

Product #	Width	c/c intervals
WM47-4801	48"	28" / 34"
WM47-6001	60"	28" / 34" / 56"
WM47-6002	60"	68"

Plastic Bin

PATENTED

RG20



Make storing, moving and inventory of small parts easier. Lightweight and resistant;
Edge at 45° angle for easy identification and easy grasp of bins;
Compatible with WM55 louvered panel, WM28 and WM9C plastic bin rail;
6" bins can be divided.

Dimensions			Product #		
W	D	H	Bin	Partition	Divider
3"	3"	2"	RG20-030302	-	-
4"	3"	2"	RG20-040302	-	-
6"	3"	2"	RG20-060302	RG22-0302	-
6"	6"	2"	RG20-060602	RG22-0602	RG24-0602
3"	3"	3"	RG20-030303	-	-
4"	3"	3"	RG20-040303	-	-
6"	3"	3"	RG20-060303	RG22-0303	-
6"	6"	3"	RG20-060603	RG22-0603	RG24-0603

Joiner for Tool Rail

WM89

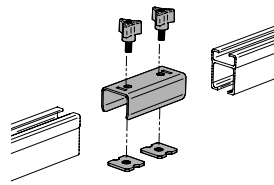

Allows assembly of two WM47 tool rails on adjacent workstations.

Product #
WM89-01

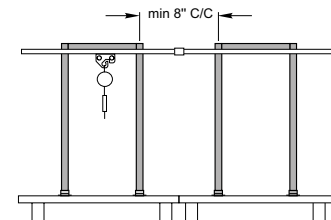

Balancer Trolley

WM48



Inserts into the WM47 tool rail;
Color : Black;
Can receive a pneumatic connector.

Product #
WM48-01

Tool Balancer

WM49

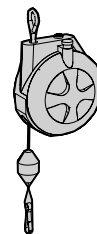

Allows hanging of tools overhead, above the work surface;
Six foot metal cable with tension adjustment;
Color : Black;
Capacity : up to 3 lb.

Product #
WM49-01



LC3012C

Components – Structure Above the Work Surface

Lamp with Magnifier and Fluorescent Light **70000635**



Attaches on work surface or on WM10 uprights with a WM68-01 light-duty arm adaptor, sold separately;

The lamp's reach on the upright may be lengthened with a WM69-12 light-duty arm, sold separately;

Dioptric grade : 3 (magnification: 1.75X);

Color : Black;

Fluorescent tube included.

Product #
70000635

Parabolic Louver (1/2" x 1/2") **WM46**

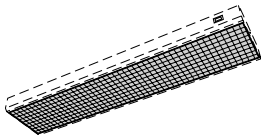

Option for WM45 overhead workstation light to reduce light reflection on a computer screen.

Product #	Width
WM46-4801	48"

Overhead LED Workstation Light **WM43**



Installs on WM18 cantilever overhead supports (must be ordered separately); Installation on single or double unit frames;

Emits a bright light while being energy efficient;

Color temperature : 6000-7000 K (cool);

Galvanized adaptor included;

Equipped with a 10 foot long cord.

Product #	Width	Uprights Width
WM43-3602	36"	28" and 34" c/c
WM43-4801	48"	28" and 56" c/c
WM43-4802	48"	34" c/c
WM43-6001	60"	34", 56" and 68" c/c

Light-Duty Arm Adaptor **WM68**

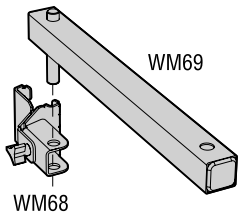

Quick assembly on WM10 uprights;

Allows the attachment of different makes of lamps or document holders with a 1/2" diameter rod pivot;

Capacity : 20 lb.

Product #	Color
WM68-01	Black

Document Holder with Arm **WM70**

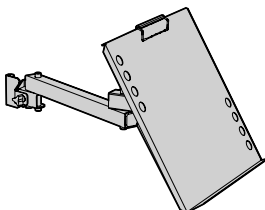

Includes a WM68 light-duty arm adaptor and a 12" WM69 light-duty arm;

The document holder (14" x 13 1/2") features a paper clip and edge on which to rest binders;

Capacity : 20 lb.

Product #	Color
WM70-01	Black

Vertical Adaptor for Electrical and Air Outlets

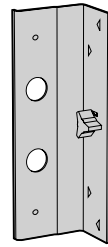

Installs on the side of WM10 upright; Can receive a power outlet strip or pneumatic connector.

Product #	Height	Color
WM41-01	8"	Black

Overhead Workstation Light **WM45**

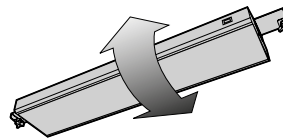

Installs on WM18 cantilever overhead supports (must be ordered separately);

2 fluorescent tubes (T8) included;

Lighting directed downward; no blinding effects;

Installation on single or double unit frames;

Attachments allow the light fixture to pivot and adjust front to back;

Color : Black;

Ballast : electronic;

Includes one K12 acrylic louver, 10' extension cord and an on/off switch.

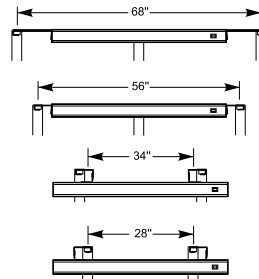

Product #	Width
WM45-48T8-28	28"
WM45-48T8-34	34"
WM45-48T8-56	56"
WM45-48T8-68	68"

Light-Duty Arm **WM69**



Attaches to the WM68 light-duty arm adaptor to extend the range of a document holder or lamp pivoting on a 1/2" diameter rod;

Capacity : 20 lb.

Product #	Width	Color
WM69-12	12"	Black

Components – Structure Above the Work Surface

Privacy Panel and Perforated Panel

WM52 / WM53

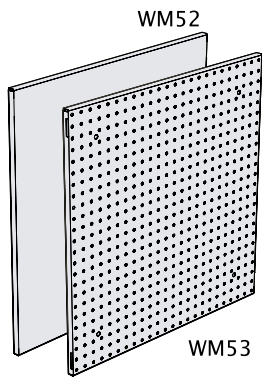

Painted steel : WM52;
Used to close the multi-purpose frame at the back;

Painted steel perforated every 1" c/c : WM53;
Used to hang accessories or tools;

WM50 panel bracket kit must be ordered separately (1 kit per panel or for 2 back-to-back panels);

- 24" H panel may be installed on 36" H and 48" H uprights
- 36" H panel must be installed on 48" H uprights only;

Note : 24" W panel must be installed on 28" c/c uprights;

Note : 30" W panel must be installed on 34" c/c uprights.

BACK-TO-BACK INSTALLATION



Product #	W x H
WM52-2424	24" x 24"
WM52-2436	24" x 36"
WM53-2424	24" x 24"
WM53-2436	24" x 36"
WM52-3024	30" x 24"
WM52-3036	30" x 36"
WM53-3024	30" x 24"
WM53-3036	30" x 36"

Panel Bracket Kit



WM50



Includes 4 brackets;
Required for installation of WM52, WM53 and WM54 panels;
Easy assembly on WM10 upright sides, no tools required.

Product #	Color
WM50-01	Black

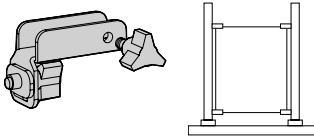

Utility Panel

WM59



Painted steel;
Hooks onto WM10 uprights;
Perforations at every 1" c/c for hanging various hooks.

Compatible with our light duty hooks : WM9F, WM9G, WM9H, WM9J and our heavy duty hooks : WM9A and WM9B;

Compatible with WM9C, WM9D, WM9M and WM9N supports;

Compatible with WM21 shelf;

Note : 28" W panel (26 holes) must be installed on 28" c/c uprights;

Note : 34" W panel (32 holes) must be installed on 34" c/c uprights.

Product #	W x H	Uprights (H)
WM59-2824	28" x 24"	36" or 48"
WM59-2836	28" x 36"	48"
WM59-3424	34" x 24"	36" or 48"
WM59-3436	34" x 36"	48"

Tackboard and Marker Panel

WM54

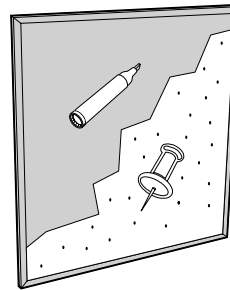

Dual-function reversible panel: tack notes to a cork board and write on a white lauzonite surface using erasable felt-tip markers;

The panel surface is magnetic;

WM50 panel bracket kit must be ordered separately.

Product #	W x H	Uprights c/c
WM54-2424	24" x 24"	28"
WM54-3024	30" x 24"	34"

Pliers Holder

WM9M



Used with utility panels (WM57 and WM59) and perforated panels (WM51, WM53 and WM56) to hold pliers;

Color: black;

Can be used to store up to 6 pliers.

Product #	W x D x H
WM9M-01	9" x 2" ½ x 2"

Louvered Panel for Plastic Bins

WM55



Painted steel;
Used to hang RG20 plastic bins;

Can be used for all brands of plastic bins with hanger lip sold on the market;

Hooks onto WM10 uprights;

Note : 28" W panel must be installed on 28" c/c uprights;

Note : 34" W panel must be installed on 34" c/c uprights.

Product #	W x H	Uprights (H)
WM55-2824	28" x 24"	36" to 48"
WM55-2836	28" x 36"	48"
WM55-3424	34" x 24"	36" to 48"
WM55-3436	34" x 36"	48"

Screwdriver Holder

WM9N



Used with utility panels (WM57 and WM59) and perforated panels (WM51, WM53 and WM56) to hold screwdrivers;

Color: black;

Keeps 6 to 12 screwdrivers close at hand.

Product #	Version	W x D x H
WM9N-01	Single	9" x 1" ½ x 2"
WM9N-02	Double	9" x 3" ¼ x 2"

Components – Structure Above the Work Surface

Straight Arm Hooks

WM9F



Can be used with perforated panels (WM51, WM53, WM56) and utility panels (WM57, WM59) for hanging accessories and tools;
Color: black;
Sold in packs of 20.

Product #	Depth
WM9F-150	1 1/2"

Double Back Single and Double Hooks

WM9H / WM9J



Can be used with perforated panels (WM51, WM53, WM56) and utility panels (WM57, WM59) for hanging accessories and tools;
Color: black;
Sold in packs of 10.

Product #	Depth	Type
WM9H-03	3"	Single
WM9H-05	5"	Single
WM9J-03	3"	Double
WM9J-05	5"	Double

Drill Holder

WM9L



Can be used with perforated panels (WM51, WM53, WM56) and utility panels (WM57, WM59) to hang a drill;
Color: black.

Product #	W x D
WM9L-01	5" x 3 1/2"

Vinyl Rub-on Identification Decal

WM9I



Use to easily identify where tools should be stored on perforated or utility panels;
The contrasting color provides fast retrieval and shows if tools are missing, and which ones;
Efficient help for 5S management;
Sold in rolls 2 feet wide and 8 feet long.

Product #
WM9I-01J

Single Loop Hooks

WM9G



Can be used with perforated panels (WM51, WM53, WM56) and utility panels (WM57, WM59) for hanging accessories and tools;
Color: black;
Sold in packs of 20.

Product #	Diameter
WM9G-150	1 1/2"
WM9G-200	2"

NOTE *Compatible with perforated panels with 1/8" holes at every 1" c/c. These panels are among the most popular on the market.*

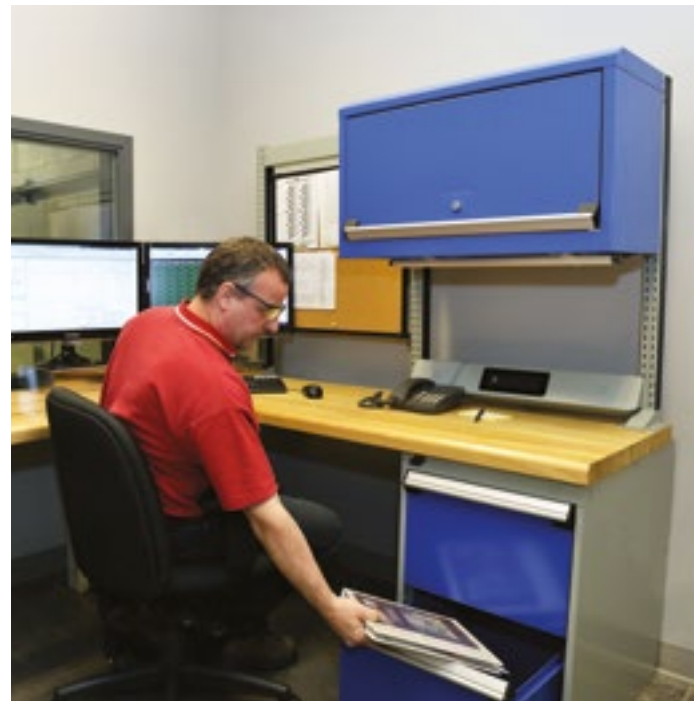

Components – Structure Above the Work Surface

Storage Cabinets

"WM" Storage Cabinet

WM75



Clips onto WM10 uprights or may be hung under the work surface;

May be secured to the uprights with tapping screws;

The storage cabinet may be subdivided with a WM20 shelf and SH52-1206 partial dividers, as needed;

Capacity : 200 lb.

Product #	W x D x H	Type
WM75-281516	28" x 15" x 16"	Cabinet without door
WM75-281516L3	28" x 15" x 16"	Cabinet with door and lock (2 keys)
WM75-341516	34" x 15" x 16"	Cabinet without door
WM75-341516L3	34" x 15" x 16"	Cabinet with door and lock (2 keys)
WM76-2816L3	28" x 16" door with lock (2 keys)	

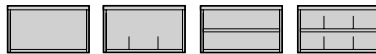
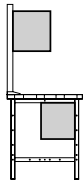

POSSIBLE CONFIGURATIONS

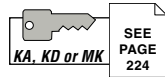

NOTE Adjustable shelf (WM20) and dividers (SH52) sold separately.

"R" Cabinet

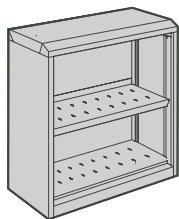

Can be anchored to a wall or installed on a WM11 structure (27", 30" and 36" W) with the RD08 adaptors for WM unit frame;

Bottom shelf included;

Adjustable shelf included with 30" H cabinet;

SH52 dividers can be installed on the shelves;

Wall anchoring not included;

Choice of doors, complete the part # with:

- 00 : Without doors
- 01 : Solid integrated door (except the R5MEA-18__)
- 02 : Polycarbonate single integrated door (for 24" H housings and over)
- 03 : Solid double integrated doors (for 24" H housings and over, 30" W and over)
- 04 : Polycarbonate double integrated doors (for 24" H housings and over, 30" W and over)
- 11 : Flipper door (for 18" H housings only)

Height	Width x Depth			
	24" x 14"	27" x 14"	30" x 14"	36" x 14"
18"	R5MCA-18__	R5MPA-18__	R5MDA-18__	R5MEA-18__
24"	R5MCA-24__	R5MPA-24__	R5MDA-24__	R5MEA-24__
30"	R5MCA-30__	R5MPA-30__	R5MDA-30__	R5MEA-30__

Wall "R" Cabinet Housing

RD00

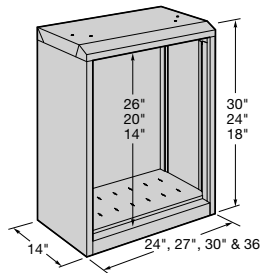

Specifically designed to be anchored to a wall or attached to the WM11 structure (27", 30" and 36" W) with the RD08 adaptors for WM unit frame;

Bottom shelf included;

Shelves, adjustable every 1" c/c, can be installed;

Capacity : 600 lb., wall and wall anchoring must be strong enough;

Wall anchoring not included;

Cabinet heights available : 18", 24" and 30";

Adaptors for cabinet RD08 must be ordered to fix the wall cabinet 27", 30" and 36" W attached to the WM11;

Order by adding the cabinet height to the number. Ex.: RD00-241418.

Product #	W x D
RD00-2414__	24" x 14"
RD00-2714__	27" x 14"
RD00-3014__	30" x 14"
RD00-3614__	36" x 14"

Adaptors for RD00 Cabinet

RD08

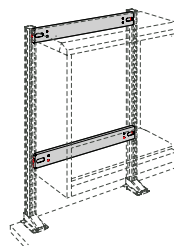

For attaching wall cabinet 27", 30" and 36" W to WM11 unit frame (2 WM10 uprights and WM15 cross member);

Easy to install.

Product #	Width
RD08-28	28"
RD08-34	34"

Adjustable Shelf

RD05

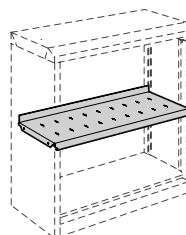

Equipped with back stop to prevent objects from falling into bottom of cabinet;

Adjustable every 1" c/c;

Can hold up to 100 lb., evenly distributed;

Compatible with SH52 dividers.

Product #	W x D
RD05-2412	24" x 12"
RD05-2712	27" x 12"
RD05-3012	30" x 12"
RD05-3612	36" x 12"

Components – Structure Above the Work Surface

Lighting Fixture for "R" Cabinet

RD09

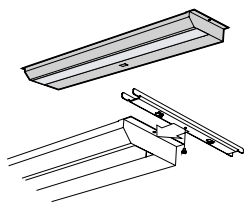

Eliminates shaded areas beneath wall cabinet;
T8 fluorescent tube included;
Includes acrylic outlet, 10' power cord and switch;
Color : Black;
Available widths: 36" and 48";
T8 ballast as energy saver.

Product #	Color
RD09-36T8	Black
RD09-48T8	Black

LED Light for "WM" Cabinet

WM44

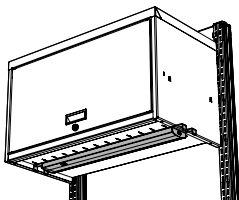

Designed to be installed underneath a WM75 cabinet.
Casts brighter light than fluorescent tubes and is more energy efficient;
Color temperature : 6000-7000 K (cool).

Product #	Width
WM44-2801	28"
WM44-3401	34"

Flipper Door for "R" Housing

RD20

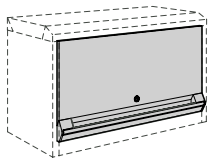

Full width handle for easy, comfortable operation;
Standard lock included;
To order econo lock-in mechanism, complete part # with B;
Compatible with RD05 adjustable shelves (must be factory intalled);
For 18" H cabinet housings only.

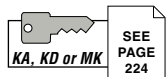

Product #	W x H
RD20-2414L3	24" x 14"
RD20-2714L3	27" x 14"
RD20-3014L3	30" x 14"
RD20-3614L3	36" x 14"

Single Integrated Door for "R" Housing

RD12 / RD13

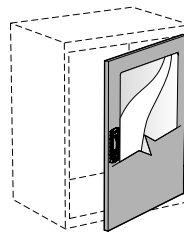

Solid integrated door : RD12;
Polycarbonate integrated door : RD13;
Compatible with RD05 adjustable shelves;
Opens 180° to allow full access to stored items;
Standard lock included;
Door widths available : 24", 27", 30" and 36";
Order by specifying the door type, as well as the door width. Ex.: RD12-2414L3.



Product #	Height
RD12- 14L3	14" Except 36"
RD - - 20L3	20"
RD - - 26L3	26"

Double Integrated Doors for "R" Housing

RD17 / RD18

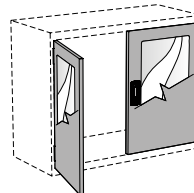

Solid double integrated doors : RD17
Polycarbonate double integrated doors : RD18
Compatible with RD05 adjustable shelves;
Open 180° to allow full access to stored items;
Standard lock included;
Order by specifying the type of door.
Ex.: RD18-3020L3.



Product #	W x H
RD - -3020L3	30" x 20"
RD - -3026L3	30" x 26"
RD - -3620L3	36" x 20"
RD - -3626L3	36" x 26"



Components – Structure Above the Work Surface

Electronic Applications

Power Outlet Strip



15A power bar with circuit breaker;
Mounts horizontally under the work surface
or riser shelf;

Order WM41 adapter (sold
separately) for installation on
WM10/WM11 uprights.

SEE
PAGE
128

Product #	Length	Extension cord	No. of outlets
70000500	9"	6'	5, without on/off switch
70000505	12"	6'	6, with on/off switch
70000506	12"	15'	6, with on/off switch

Power Outlet Channel



WM40

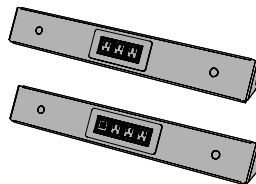

Hooks easily onto WM10 uprights;
Each power outlet channel is equipped with
either 3 12A outlets for 15A circuit or 3 12A
outlets for 15A circuit plus 2 USB ports;
Both options include 2 knockouts for
pneumatic fittings;

Order by choosing the width of the power
outlet channel : 28" or 34".

Product #	Option
WM40-__1001	3 12A outlets and 2 knockouts for pneumatic fittings
WM40-__1101	3 12A outlets, 2 knockouts for pneumatic fittings and a plate
WM40-__1201	3 12A outlets, 2 USB ports and 2 knockouts for pneumatic fittings
WM40-__1301	3 12A outlets, 2 USB ports, 2 knockouts for pneumatic fittings and a plate