

Basic Workbench



WSA2019

BASIC WORKBENCH

Whether you are looking for a basic workbench with two legs and a top, or a specialized table that is stationary, mobile, or adjustable in height, you will find a solution for each and every application.

You will appreciate their versatility as they evolve with your changing needs by simply adding any of the numerous easy-to-install accessories.

Rousseau offers you several work surface dimensions for each of the surfaces offered: painted steel, stainless steel, laminated wood, laminated Acrylic/PVC, laminated and dissipative plastic tops. Rousseau, the one-stop solution to simplify your life!

Distributed by:
Custom Equipment Company
866-333-0728
sales@custommhs.com
www.custommhs.com

Basic Workbench

The Rousseau Advantages



"Inverted hat" shaped top part for excellent rigidity. Optional power supply available.



Doors close and secure the underside of the work surface in the solid and polycarbonate versions.



Drawers on precision ball bearing slide system. Several drawer and unit heights.

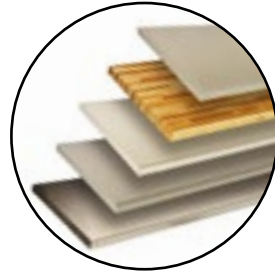

Choose from our different work surfaces for specific applications.

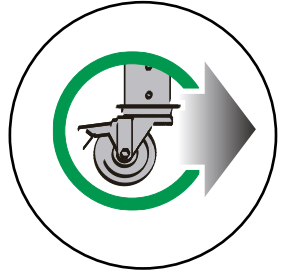

Many of our workbenches can be made mobile in order to better meet your needs.

General Dimensions

Heights available

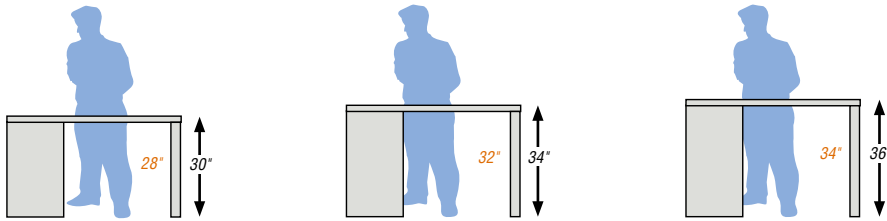

Index	Page(s)
Basic Workbench	102 - 103
Proposals	104 - 107
Components	
– Work surface	108 - 110
– Structure under the work surface	110 - 115

NOTE Total height indicated includes 1 3/4" thick top. SEE PAGE 108

NOTE Extensions offered for other heights SEE PAGE 113

Widths and depths available

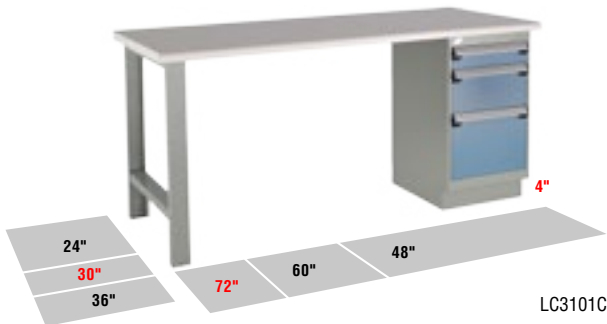

WSW1032



LG2010



LG7131C

Proposals

Basic Workbenches

Basic Workbench with Stringer



WSA2031

- 1 top of your choice;
- 2-27" D x 32" H legs;
- 1 stringer.

Dimensions			Type of Top			
W	D	H	Painted Steel	Lam. Wood	Plastic Lam.	Acrylic/PVC
60"	30"	34"	WS_1031	WS_2031	WS_3031	WS_9031
72"	30"	34"	WS_1035	WS_2035	WS_3035	WS_9035
72"	36"	34"	WS_1039	WS_2039	WS_3039	WS_9039

To order, complete the part number according to the following:
A for a stationary table, **W** for a mobile table. **Ex.: WSW2031**

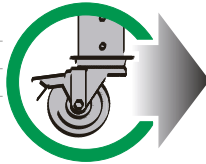

This table can be made mobile.

Mobile model (total height 35") includes the following additional accessories:

- 2 pairs of caster adaptors for legs;
- 1 pair of 4" rigid casters;
- 1 pair of 4" swivel casters with total-lock brake;
- 1 footrest;

Note : Leg height on mobile models is 28".

Workbench with Shelf



WSA2019

- 1 top of your choice;
- 2-27" D x 32" H legs;
- 2 shelves, each 12" D;
- 1 stringer.

Dimensions			Type of Top			
W	D	H	Painted Steel	Lam. Wood	Plastic Lam.	Acrylic/PVC
60"	30"	34"	WS_1019	WS_2019	WS_3019	WS_9019
72"	30"	34"	WS_1023	WS_2023	WS_3023	WS_9023
72"	36"	34"	WS_1027	WS_2027	WS_3027	WS_9027

To order, complete the part number according to the following:
A for a stationary table, **W** for a mobile table. **Ex.: WSW2019**

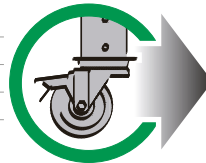

This table can be made mobile.

Mobile model (total height 35") includes the following additional accessories:

- 2 pairs of caster adaptors for legs;
- 1 pair of 4" rigid casters;
- 1 pair of 4" swivel casters with total-lock brake;

Note : Leg height on mobile models is 28".

Closed Table



WSA2070

- 1 top of your choice;
- 2-27" D x 32" H legs;
- 1 sliding doors with L3 lock;
- 2 side panels and 1 back panel;
- 3 shelves, each 12" D;
- 2 leg crossbars.

Dimensions			Type of Top			
W	D	H	Painted Steel	Lam. Wood	Plastic Lam.	Acrylic/PVC
60"	30"	34"	WS_1070	WS_2070	WS_3070	WS_9070
72"	30"	34"	WS_1071	WS_2071	WS_3071	WS_9071
72"	36"	34"	WS_1072	WS_2072	WS_3072	WS_9072

To order, complete the part number according to the following:
A for a stationary table, **W** for a mobile table. **Ex.: WSW2070**

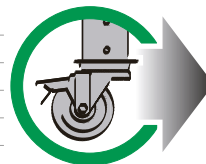

This table can be made mobile.

Mobile model (total height 35") includes the following additional accessories:

- 2 pairs of caster adaptors for legs;
- 1 pair of 4" rigid casters;
- 1 pair of 4" swivel casters with total-lock brake;

Note : Leg height on mobile models is 28".

Adjustable Workbench



WSA3050

Dimensions			Type of Top			
W	D	H	Painted Steel	Lam. Wood	Plastic Lam.*	Dissipative**†
60"	30"	30" to 42"	WSA1050	WSA2050	WSA3050*	WSA4050**†
72"	30"	30" to 42"	WSA1051	WSA2051	WSA3051*	WSA4051**†
72"	36"	30" to 42"	WSA1052	WSA2052	WSA3052*	WSA4052**†

1 top of your choice;
 2-27" D x 27" H open legs for lift system;
 1 hydraulic lifting system;
 1 Anti-skid leveling glides;
 12" vertical adjustment (30" - 42");
 1-17" high stringer;
 Compatible with WM accessories;
 System capacity: 825 lb.

Note: These models cannot be used in mobile applications.

* 725 lb capacity.

† Models with dissipative tops come with 1 grounding block, 1 grounding cord and 1 ground wrist strap.

SEE PAGE 133

Desk with Closed Legs



WSA3043

Dimensions			Type of Top			
W	D	H	Painted Steel	Lam. Wood	Plastic Lam.	Acrylic/PVC
60"	30"	30"	WSA1043	WSA2043	WSA3043	WSA9043
72"	30"	30"	WSA1044	WSA2044	WSA3044	WSA9044

1 top of your choice;
 1 back panel;
 2-27" D x 28" H closed legs;
 1 shelf, 12" D.

Note: These models cannot be used in mobile applications.

Closed Desk with Closed Legs



WSA3170

Dimensions			Type of Top			
W	D	H	Painted Steel	Lam. Wood	Plastic Lam.	Acrylic/PVC
60"	30"	34"	WSA1170	WSA2170	WSA3170	WSA9170
72"	30"	34"	WSA1171	WSA2171	WSA3171	WSA9171
72"	36"	34"	WSA1172	WSA2172	WSA3172	WSA9172

1 top of your choice;
 1 back panel;
 2-27" D x 32" H legs;
 3 shelf, each 12" D;
 2 legs crossbars;

1 front finishing panel;
 1 back finishing panel;
 1 sliding door with L3 lock.

Note: These models cannot be used in mobile applications.

Open Double Workbench



WSA1904

Dimensions			Type of Top			
W	D	H	Painted Steel	Lam. Wood	Plastic Lam.	Acrylic/PVC
8'(2 x 48")	30"	34"	WSA1902	WSA2902	WSA3902	WSA9902
10'(2 x 60")	30"	34"	WSA1904	WSA2904	WSA3904	WSA9904
12'(2 x 72")	30"	34"	WSA1906	WSA2906	WSA3906	WSA9906

2 tops of your choice;
 3-27" D x 32" H legs;
 2 stringers;
 4 steel shelves, each 12" D;

1 shelf adaptor for common leg;
 1 stringer extension for common leg.

Note: These models cannot be used in mobile applications.

Proposals

Closed Double Workbench



WSA2971

Dimensions			Type of Top			
W	D	H	Painted Steel	Lam. Wood	Plastic Lam.	Acrylic/PVC
8'(2 x 48")	30"	34"	WSA1971	WSA2971	WSA3971	WSA9971
10'(2 x 60")	30"	34"	WSA1973	WSA2973	WSA3973	WSA9973
12'(2 x 72")	30"	34"	WSA1975	WSA2975	WSA3975	WSA9975

- 2 tops of your choice; _____
- 3-27" D x 32" H legs; _____
- 2 side panels and 2 back panels; _____
- 4 steel shelves, each 12" D; _____
- 1 shelf adaptor for common leg; _____

- 2 sets of sliding doors with L3 lock; _____
- 2 side extensions for common leg. _____

Note : These models cannot be used in mobile applications.

Workbench with Compact Cabinet



LG2101C

- 1 top of your choice; _____
- 1-27" D x 32" H leg; _____
- 1 "L" compact cabinet with 4" base; _____
- 1 pair of cabinet attachment bars. _____

Dimensions			Type of Top			
W	D	H	Painted Steel	Lam. Wood	Plastic Lam.	Acrylic/PVC
60"	30"	34"	L_1101C	L_2101C	L_3101C	L_9101C
72"	30"	34"	L_1102C	L_2102C	L_3102C	L_9102C
72"	36"	34"	LH1103C	LH2103C	LH3103C	LH9103C

To order, complete part number according to the following:

G for a stationary bench with 21" deep cabinet (for 30" D benches only), **H** for a stationary bench with 27" deep cabinet (for 30" D and 36" D benches only), **J** for a mobile bench.

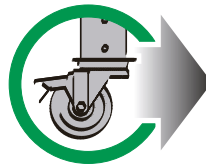

This table can be made mobile.

Mobile model (total height 35") includes the following additional accessories:

- 1 integrated lock-in mechanism for drawers; _____
- 1 base for casters for compact cabinet; _____
- 1 pair of caster adaptors for leg; _____
- 1 pair of 4" rigid casters; _____
- 1 pair of 4" swivel casters with total-lock brake; _____
- 1 footrest. _____

Note : Cabinet base not included with mobile model.



27" deep cabinets are recommended for mobile workstations or workstations with multi-purpose frames.

Workbench with Two Compact Cabinets



LG2201C

Dimensions			Type of Top			
W	D	H	Painted Steel	Lam. Wood	Plastic Lam.	Acrylic/PVC
60"	30"	34"	L_1201C	L_2201C	L_3201C	L_9201C
72"	30"	34"	L_1202C	L_2202C	L_3202C	L_9202C
72"	36"	34"	LH1203C	LH2203C	LH3203C	LH9203C

To order, complete part number according to the following:

G for a stationary bench with 21" deep cabinet (for 30" D benches only), **H** for a stationary bench with 27" deep cabinet (for 30" D and 36" D benches only), **J** for a mobile bench.

- 1 top of your choice; _____
- 2 "L" compact cabinets with 4" bases; _____
- 2 pairs of cabinet attachment bars. _____

Note: These models cannot be used in mobile applications.



27" deep cabinets are recommended for mobile workstations or workstations with multi-purpose frames.

Workbench with Suspended Compact Cabinet



LG2001

Dimensions			Type of Top			
W	D	H	Painted Steel	Lam. Wood	Plastic Lam.	Acrylic/PVC
60"	30"	34"	LG1001	LG2001	LG3001	LG9001
72"	30"	34"	LG1002	LG2002	LG3002	LG9002
72"	36"	34"	LG1003	LG2003	LG3003	LG9003

1 top of your choice;
 2-27" D x 32" H legs;
 1 stringer;
 1-21" deep "L" compact cabinet;
 1 pair of cabinet attachment bars.

Note: Maximum capacity of 50 lb. per drawer in a suspend cabinet application using RA70.

Note: These models cannot be used in mobile applications.

Desk with Compact Cabinet



LG3107

Dimensions			Type of Top		
W	D	H	Painted Steel	Lam. Wood	Plastic Lam.
60"	30"	30"	LG1107	LG2107	LG3107
72"	30"	30"	LG1108	LG2108	LG3108
72"	36"	30"	LH1109	LH2109	LH3109

1 top of your choice;
 1-27" D x 28" H closed leg;
 1 "L" compact cabinet of 21" D;
 1 pair of cabinet attachment bars.



27" deep cabinets are recommended for workstations with multi-purpose frames.

Note : These models cannot be used in mobile applications.

Workbench with Heavy-Duty Drawers



R5XDG-3004

1 laminated hardwood top WS14-4830A
 2-27" D x 32" H legs; WS20-2732
 1 drawer unit RD77-30270801
 2 shelves WS50-4812
 1 stringer WS22-4805

Product #	W x D x H
R5XDG-3004	48" x 30" x 34"

Note : These models cannot be used in mobile applications.



R5WH5-2007

1 laminated hardwood top WS14-6030A
 1 heavy-duty cabinet with partitioning R5ACG-3013
 1-27" D x 32" H leg; WS20-2732

Product #	W x D x H
R5WH5-2007	60" x 30" x 34"

Note : These models cannot be used in mobile applications.

Components – Work Surfaces

Work Surfaces

Painted Steel Top

WS10



Top for industrial, maintenance, repair or assembly applications;
 Thickness : 1 3/4";
 2 steel crossbars for attaching legs;
 3 wood crossbars (2" x 4") for attaching cabinets and other accessories;
 May be reinforced or soundproofed with a WS75 wood filler;
 Excellent impact resistance;
 Powder paint.

Stainless Steel Top

WS12



Top for industrial, maintenance, repair or assembly applications or when solvents, oils or other chemical products are being used;
 Thickness : 1 3/4". 12 gauge steel;
 Brushed finish #4, attractive appearance;
 2 steel crossbars for attaching legs;
 3 wood crossbars (2" x 4") for attaching cabinets and other accessories;
 May be reinforced or soundproofed by adding a WS75 wood filler;
 Excellent corrosion resistance;
 Excellent chemical resistance (can be in prolonged contact with a substance);
 Note : The RC35 top is also compatible with the fixed workstations (not recommended for mobile applications), see page 12.

Laminated Hardwood Top

WS14



Top for general industrial applications;
 Thickness : 1 3/4";
 Made with varnished hardwood slats;
 90° radius front edge for more comfort;
 Good impact resistance;
 Attractive appearance.

Resistant Acrylic / PVC Plastic Laminated Top

WS08

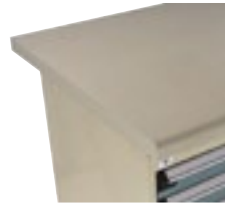

Ideal for assembly stations or for applications using solvents, oils or other chemical products;
 Thickness : 1 1/2";
 Color : Gray;
 Core made of particle board;
 Finish : sheet of gray polymer;
 Deluxe quality laminated top;
 Excellent chemical product resistance (can be in prolonged contact with a substance);
 Superior abrasion resistance compared to standard laminated top;
 Superior impact resistance compared to standard laminated top;
 Attractive appearance.

Plastic Laminated Top

WS16



Top for general applications. Ideal for assembly, quality control and packaging applications;
 Thickness : 1 1/2";
 Color : White;
 Attractive appearance;
 Easy to clean;
 90° radius front edge for more comfort.

Dissipative Top

WS17



Top for electronics applications. Ideal for assembly or electronics inspection stations;
 Thickness : 1 1/2";
 Color : White;
 Attractive appearance;
 Easy to clean;
 90° radius front for more comfort;
 Dissipates electric charges that can damage electronic components;
 Resistance point to point and point to ground between 10⁶ and 10⁹ Ω.

NOTE Please refer to W54 tech sheet for capacity according to configuration. Available on Multi Tool CD.

NOTE The 21" deep cabinets are compatible with the 24" WS10/12 tops.
 The 21" deep cabinets are not compatible with the 30" and 36" WS10/12 tops.
 The 27" deep cabinets are compatible with the 30" and 36" WS10/12 tops.

Dimensions		Types of Top					
W	D	Acrylic/PVC Plastic Laminated	Painted Steel	Stainless Steel	Laminated Hardwood	Plastic Laminated	Dissipative
36"	24"				WS14-3624A	WS16-3624A*	
	30"				WS14-3630A	WS16-3630A*	
48"	24"	WS08-4824A*	WS10-4824	WS12-4824 *	WS14-4824A	WS16-4824A*	WS17-4824A*
	30"	WS08-4830A*	WS10-4830	WS12-4830 *	WS14-4830A	WS16-4830A	WS17-4830A*
	36"	WS08-4836A*	WS10-4836	WS12-4836 *	WS14-4836A*	WS16-4836A*	WS17-4836A*
60"	24"	WS08-6024A*	WS10-6024	WS12-6024 *	WS14-6024A	WS16-6024A	WS17-6024A*
	30"	WS08-6030A	WS10-6030	WS12-6030 *	WS14-6030A	WS16-6030A	WS17-6030A
	36"	WS08-6036A*	WS10-6036	WS12-6036 *	WS14-6036A	WS16-6036A	WS17-6036A*
72"	24"	WS08-7224A	WS10-7224	WS12-7224 *	WS14-7224A	WS16-7224A	WS17-7224A*
	30"	WS08-7230A	WS10-7230	WS12-7230 *	WS14-7230A	WS16-7230A	WS17-7230A
	36"	WS08-7236A	WS10-7236	WS12-7236 *	WS14-7236A	WS16-7236A	WS17-7236A

NOTE *Please check with your customer service representative for lead time.

Components – Work Surfaces

Steel Top Crossbar

WS11 / WS13

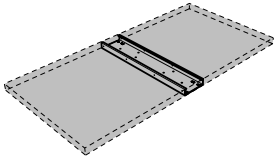

Painted steel : WS11;
Stainless steel : WS13;
May be attached to center of steel top (WS10 or WS12) for reinforcement;
To order, complete the part # with steel choice needed. Ex.: WS11-24.

Product #	W x D
WS__-24	6" x 24"
WS__-30	6" x 30"
WS__-36	6" x 36"

Wood Filler for Steel Top

WS75

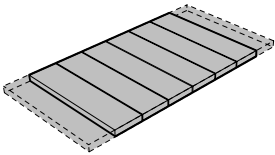

Made from wooden crossbars;
Inserted into WS10 and WS12 steel tops for soundproofing;
Increases solidity of steel tops;
Allows attachment of accessories beneath the work surface;
Depths available : 24", 30" and 36";
To order, complete the part # with depth wanted.

Product #	Width
WS75-48	48"
WS75-60	60"
WS75-72	72"

Wood Crossbar for Steel Top

WS76

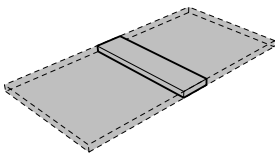

Allows attachment of cabinets, hanging cabinets and drawer units. Also used to secure back panels beneath the steel top;
Depths available : 24", 30" and 36";
To order, complete the part # with depth wanted;
Note : 3 crossbars (2" x 4") are included with each WS10 and WS12 steel top.

Product #	W x H
WS76-0202	2" x 2"
WS76-0204	4" x 2"
WS76-0208	8" x 2"

Back and Side Stops

WS18 / WS98

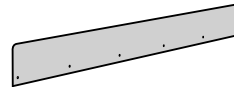

Painted steel : WS18;
Stainless steel : WS98;
Can be attached to back or sides according to top dimensions;
May be installed on all types of tops;
Height : 5". Clear top by approx. 3 1/4";
To order, complete the part # with steel choice needed. Ex.: WS18-2405.

Product #	Length
WS__-2405	24"
WS__-3005	30"
WS__-3605	36"
WS__-4805	48"
WS__-6005	60"
WS__-7205	72"

Sliding Keyboard Tray

WS90-01

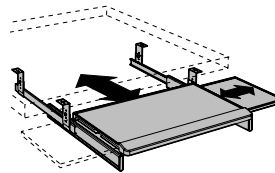

May be mounted on all surfaces;
Mouse tray slides to the left or right side, as needed;
Usable area : 8 1/2" x 20 1/2";
Mouse tray : 9 3/8" x 9 1/8".
Takes 22" W under the surface.

Product #	Color
WS90-01	Black

Adjustable Keyboard Tray

WS90-02

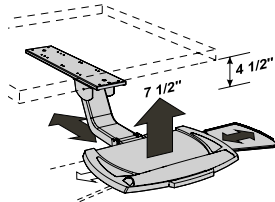

Support with articulating arm designed for use in the sit/stand position;
May be mounted on all surfaces;
Includes:
– mouse tray, slides to the left or right side, as needed
– ergonomic palm rest
Slides under the work surface for storage;
Sturdy construction;
Usable area : 9 1/2" x 20 1/2";
Mouse tray : 9 3/8" x 9".
Takes 30" W under the surface.

Product #	Color
WS90-02	Black



Components – Work Surfaces

Side Brackets for Top

RA73

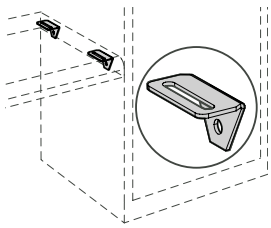

Capacity of 500 lb. per pair or 1000 lb. for 4;
Compatible with all cabinet depths;
Compatible with all types of work tops;
Galvanized steel.

Product #	
RA73-02	1 pair
RA73-04	2 pairs

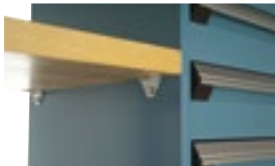

CPU Support

WS92



May be mounted on all surfaces;
Handle allows width of plastic side support to be adjusted;
Adjustments accommodate computers with dimensions of 3 1/2" to 9 1/4" width by 12 1/2" to 22 1/2" height;
Width : 8 3/8" to 11 1/2";
Depth : 6 3/4" (8 1/2" with handle);
Height : 18" to 26".

Product #	Color
WS92-01	Black

Laminated Hardwood Top

SR90

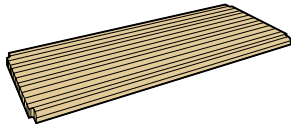

Designed to be installed between two shelving units;
A pair of SH74-24 top supports must be ordered for installation.

Product #	W x D
SR90-6024A	60" x 24"
SR90-7224A	72" x 24"

Top Supports

SH74

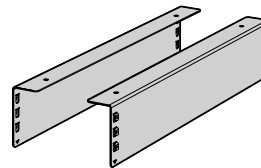

Sold in pairs;
Designed to support a SR90 laminated hardwood top between two shelving units;
Easy hook assembly.

Product #	Depth
SH74-24	24"

Structural Components

Open Leg



WS20

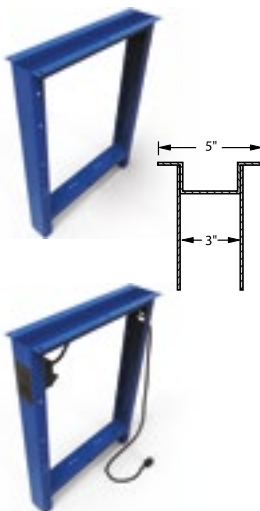

Three basic heights : 28", 32" and 34";
WS21 leg extensions can be added according to need;
"Inversed" hat shaped top for added strength;
A second leg crossbar, WS24, can be added to permit installation of WS50 shelves;
Can be closed with a WS62 side panel;
To add a power strip with two 12A outlets, add -20 to the product number;
To add a power strip with one 12A outlet and two USB ports, add -22 to the product number.

Product #	D x H	Surface Depth
WS20-2128-	21" x 28"	24" and 30"
WS20-2132-	21" x 32"	24" and 30"
WS20-2134-	21" x 34"	24" and 30"
WS20-2728-	27" x 28"	30" and 36"
WS20-2732-	27" x 32"	30" and 36"
WS20-2734-	27" x 34"	30" and 36"

Closed Leg



WS25

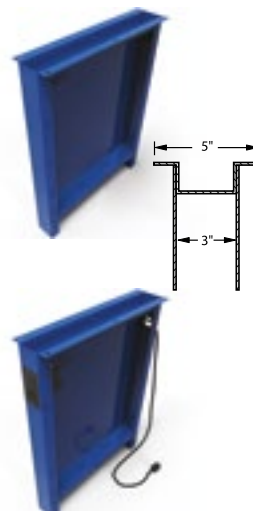

For office applications where appearance is important;
Three basic heights : 28", 32" and 34";
"Inversed hat" shaped top for added strength;
One closed side. The face and exterior side have no holes; accessory fixing zones on inner face;
A second leg crossbar, WS24, may be added to permit installation of WS50 shelves;
Compatible with the levelling glides (WS26);
Not compatible with the leg extensions (WS21);
To add a power strip with two 12A outlets, add L-20 to the product number for the left leg and R-20 for the right leg;
To add a power strip with one 12A outlet and two USB ports, add L-22 to the product number for the left leg and R-22 for the right leg.

Product #	D x H	Surface Depth
WS25-2128 -	21" x 28"	24" and 30"
WS25-2132 -	21" x 32"	24" and 30"
WS25-2134 -	21" x 34"	24" and 30"
WS25-2728 -	27" x 28"	30" and 36"
WS25-2732 -	27" x 32"	30" and 36"
WS25-2734 -	27" x 34"	30" and 36"

Floor Anchor Hardware Kit

WS80

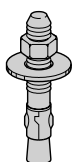

Serves to anchor legs to floor;
Includes 4 concrete screws.

Product #
WS80

Components – Structure Under the Work Surface

Stringer

WS22

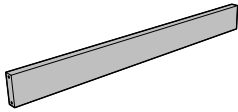

Attaches between the two legs at the rear, to strengthen structure;
Standard widths that fit top surface widths;
May serve as a back for shelves beneath work surface.

Product #	Width	Surface Width
WS22-4805	39"	48"
WS22-6005	51"	60"
WS22-7205	63"	72"

Leg Crossbar



WS24

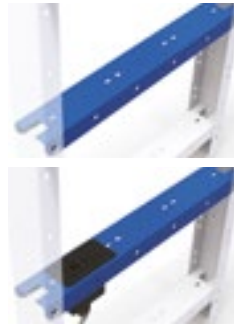

Provides space for a second row of shelves under the work surface;

Can be mounted to a WS20 open leg or WS25 closed leg;

To add a power strip with two 12A outlets, add -20 to the product number;

To add a power strip with one 12A outlet and two USB ports, add -22 to the product number.

Product #	Leg Depth
WS24-21-__	21"
WS24-27-__	27"

Open Wall-Mounted Leg

WS95

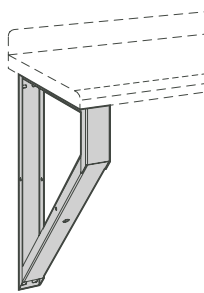

500 lb. capacity per leg; 1000 lb. capacity per pair (assuming that wall and wall anchoring are sufficient);

Anchoring hardware not provided by Rousseau;

Designed for 24", 30" and 36" deep tops;

Compatible with all types of tops offered by Rousseau;

Compatible with WS18 back stop and WM10 & WM11 multi-purpose uprights;

Possible to install WS96 crossbars and 12" deep WS50 shelf (available as an option).

Product #	D x H
WS95-2428	22 5/8" x 29 7/16"

Adjustable Footrest

WS23

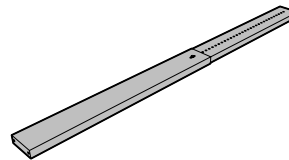

Adjustable width; can be extended by sliding the two parts;

Required for all mobile workstations;

May be attached to leg crossbars or on the sides of cabinets to strengthen structure.

Product #	Width Adjustment
WS23-1624	16" to 24"
WS23-2440	24" to 40"
WS23-4072	40" to 72"

Choice of Footrests Depending on configuration	Top Width		
	48"	60"	72"
2 legs	WS23-2440	WS23-4072	WS23-4072
1 leg and 1 "L" compact cabinet	WS23-2440	WS23-2440	WS23-4072
2 "L" compact cabinet	—	WS23-1624	WS23-2440
1 leg and 1 RA30-2427 cabinet	—	WS23-2440	WS23-4072
1 leg and 1 RA30-3027 cabinet	—	WS23-2440	WS23-2440
1 leg and 1 RA30-3624 cabinet	—	WS23-1624	WS23-2440

Crossbar for Wall Leg

WS96

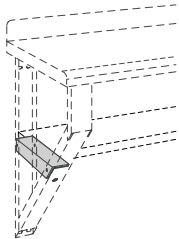

Installation of 12" deep WS50 shelf is possible (available as an option);

Use with WS95 wall-mounted leg.

Product #	Depth
WS96-24	13 3/4"

Cabinet Attachment Bars

RA70

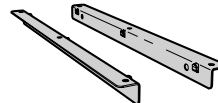

Sold in pairs;

Designed to attach the cabinet under the work surface without having to remove the drawers;

Required to attach a 21" D cabinet to a 30" D WS10/WS12 top or a 27" D cabinet to a 36" D WS10/WS12 top.

Note : Absolutely required with Steel top WS10/12 when the cabinet is installed at 1 1/2" from the side of the workstation.

Product #	For Cabinet
RA70-21	21" D
RA70-27	27" D

Corner Gussets for Leg

WS28

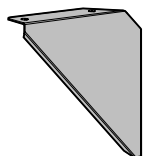

Sold in pairs;

Mount under and attach to leg to reinforce structure;

Recommended for mobile workstations with tops constructed with particleboard or plastic laminated panel;

Note : To find out the capacity of a mobile workstation with gussets, please refer to W54 tech sheet or contact your customer service representative;

Note: Not compatible with WS10 and WS12.

Product #
WS28-01

Components – Structure Under the Work Surface

Steel Shelf

WS50 / WS56

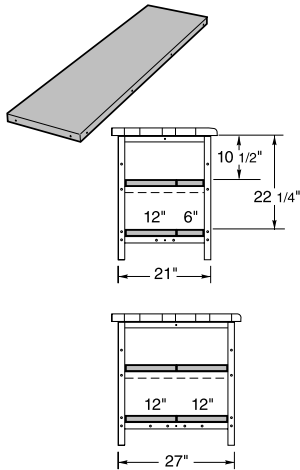

Painted steel : WS50;
Stainless steel : WS56;
Thickness : 1 1/4";
May be installed on leg crossbars or WS24 on shelf supports WM27;

SEE PAGES 111, 126

Shelf combinations :
– 21" deep legs : 1-6" D + 1-12" D shelves
– 27" deep legs : 2-12" D shelves;

Order by completing the part # with the steel choice.

Product #	W x D	Surface Width
WS_-4806	45" x 6"	48"
WS_-4812	45" x 12"	48"
WS_-6006	57" x 6"	60"
WS_-6012	57" x 12"	60"
WS_-7206	69" x 6"	72"
WS_-7212	69" x 12"	72"

Side Panel

WS62

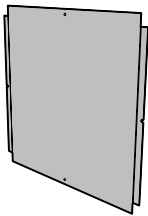

For installation on open legs;
Fits 28", 32" and 34" high legs.

Product #	D x H	Leg Depth
WS62-2128	20" x 25"	21"
WS62-2728	26" x 25"	27"

Back Panel

WS63

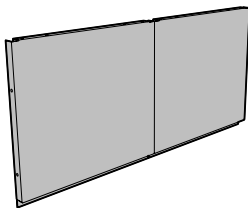

For installation behind WS20 open legs or WS25 closed legs;

Available with:
– 48" (1 piece)
– 60" and 72" (2 pieces)

Fits 28", 32" and 34" high legs.

Product #	W x H	Surface Width
WS63-4828	39" x 24"	48"
WS63-6028	51" x 24"	60"
WS63-7228	63" x 24"	72"

Power Outlet Channel



WS7B

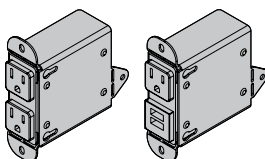

Mounts directly under a wood or laminate work surface;
15' wire;

Available in a power strip with two 12A outlets or one 12A outlet and two USB ports.

Product #	Option
WS7B-20	2 power outlets
WS7B-22	1 power outlet + 2 USB ports

Shelf Adaptor for Common Leg

WS78

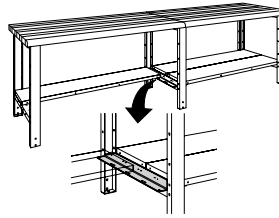

Must be ordered to install WS50 shelves on a common leg;
Not compatible with the side panels (WS62).

Product #	Leg Depth
WS78-0321	21"
WS78-0327	27"

Stringer Extension for Common Leg

WS79

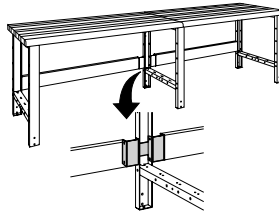

Must be ordered to install WS22 stringers on a common leg.

Product #
WS79-0305

Side Extension for Common Leg

WS64

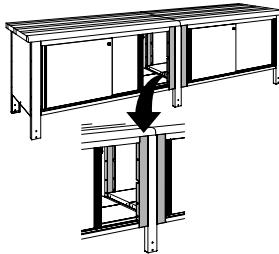

Sold in pairs: one piece for the front, one for the rear;
Required to mount WS60 sliding doors or WS63 back panels to a common leg.

Product #	Height
WS64-0325	25"

Adaptor for WS50 Shelf

RC15

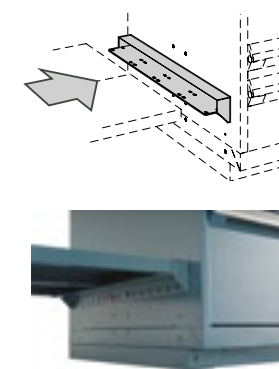

Allows for installation of a WS50 shelf between 2 RA30 or 2 LA30 cabinets, between a RA30 cabinet and a WS20 leg or between a LA30 cabinet and a WS20 leg;

Attached in the holes on side of cabinet (knockouts provided).

Product #	Depth
RC15-12	12" (1-12" D shelf or 2-6" D)
RC15-18	18" (1-12" D shelf+1-6" D or 3-6" D)
RC15-24	24" (2-12" D shelves or 4-6" D)

Power Outlet Strip

15A power bar with circuit breaker;
Mounts horizontally under the work surface or riser shelf;
Mounting hardware included.

Product #	Length	Extension	No. of outlets
70000500	9"	6'	5, without on/off switch
70000505	12"	6'	6, with on/off switch
70000506	12"	15'	6, with on/off switch

Components – Structure Under the Work Surface

Sliding Doors

WS60 / WS61

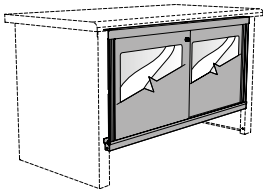

Sliding doors : WS60;
Sliding polycarbonate doors : WS61;
Allow user to close and lock the area beneath the work surface (standard lock included);
Smooth, quiet movement;
Fit workstations with 28", 32" or 34" high legs;
Order by specifying the choice of door.
Ex.: WS61-4828L3 for 39" W x 24" H sliding polycarbonate doors.

Product #	W x H	Surface Width
WS_-4828L3	39" x 24"	48"
WS_-6028L3	51" x 24"	60"
WS_-7228L3	63" x 24"	72"

Paper and Cardboard Spool Support

WS86

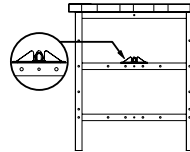
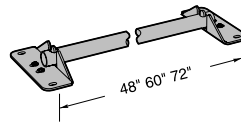

Installs under the work surface on the WS24 leg crossbars (sold separately);
Includes two end brackets and one rod;
Rod diameter : 1";
One person alone may insert the spool by pivoting one end of the rod;
Capacity : 75 lb;
Note: Up to two units can be installed on a WS24-21 and up to three units on a WS24-27.

Product #	Width	Color
WS86-48	48"	Black
WS86-60	60"	Black
WS86-72	72"	Black

Finishing Panel

WS65 / WS66



Front finishing panel : WS65;
Rear finishing panel : WS66;
Allows you to close off the space under a set of sliding doors on both the front and back of the workstation;
Three heights available : 4", 8" and 10";
Compatible with WS25 closed legs 28", 32" or 34" H;
Order by indicating the type of panel and height required. Ex.: WS65-4808 for a front finishing panel 48" W x 8" H.

Product #	W x H	Height Closed Legs
WS_-4804	48" x 4"	28"
WS_-4808	48" x 8"	32"
WS_-4810	48" x 10"	34"
WS_-6004	60" x 4"	28"
WS_-6008	60" x 8"	32"
WS_-6010	60" x 10"	34"
WS_-7204	72" x 4"	28"
WS_-7208	72" x 8"	32"
WS_-7210	72" x 10"	34"

Packaging Shear Cutter

WM87

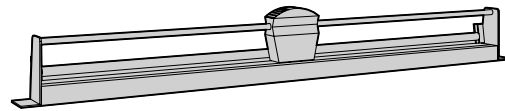

Designed for cutting paper and corrugated rolls, plastic, packing foam, bubble wrap, etc. For materials up to 36" wide;
Cuts in both directions.

Product #	Material Cutting Width	Overall Width
WM87-01	36"	48"

Leveling Glides

WS26

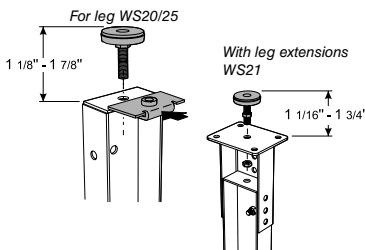

Sold in pairs;
Serve to adjust the height of legs on uneven floor surfaces;
To use with a "L" compact cabinet, see leveling glide kit LA74.

Product #
WS26

SEE PAGE 31

Casters



_B81-03



_B84-03



_B85-03

Sold in pairs;
3 types of casters available: fixed, swivel, swivel with total-lock brake system (on wheel and swivel);
Dark gray polyurethane tread won't mark floors.
Superior industrial quality;
Order by specifying the type of cabinet "L" or "R" E.x.: RB81-01;

Note: Casters install directly under an "R" cabinet (without base);

Note: LB93 caddy or LB96 base for casters is required for use with an "L" compact cabinet.

SEE PAGE 56

Product #	Caster type	Capacity	Wheel Height	Total Height
_B81-01	Fixed	420 lb	4"	5 1/8"
_B81-02	Swivel	420 lb	4"	5 1/8"
_B81-03	Swivel with total-lock brake system	420 lb	4"	5 1/8"
_B84-01	Fixed	900 lb	6"	7 1/2"
_B84-02	Swivel	900 lb	6"	7 1/2"
_B84-03	Swivel with total-lock brake system	900 lb	6"	7 1/2"
_B85-01	Fixed	1000 lb	6"	7 1/2"
_B85-02	Swivel	1000 lb	6"	7 1/2"
_B85-03	Swivel with total-lock brake system	1000 lb	6"	7 1/2"

Leg Extensions/Caster Adaptors

WS21

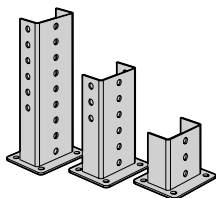

For open legs only;
Sold in pairs;
Three heights : 3", 6" and 9";
The 6" and 9" extensions adjust leg height;
Casters may be installed with 3" and 6" extensions; the 9" extensions must not be used with casters.

Product #	Height	Possible Adjustment	Type of Caster
WS21-0306	3"	—	4" or 6"
WS21-0606	6"	To 3"	4" or 6"
WS21-0904	9"	To 6"	Not compatible

Components – Structure Under the Work Surface

Preconfigured Models

Here are some of the most popular cabinets for workstations.

"L" Compact Cabinets :

27" deep cabinets are required for 36" deep workstations and are recommended with a multi-purpose stand and on 30" deep mobile stations; Come with RA70 cabinet attachment bars to install and suspend the cabinet under the work surface;

For a 12" drawer : Order LG31 hanging folder bars for letter (8½" x 11") or legal size (8½" x 14") folders;

Can be ordered with or without a central lock (L3). To order a cabinet housing with a central lock, add L3 to product number.

SEE PAGE 29

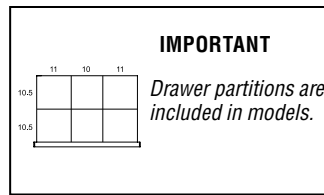

NOTE
For drawers without partitioning, complete the even number following the two last digits of the model.
Ex.: L3ABD-2851C with L3ABD-2852C without

Number of Compartments (layout code)		
Drawer Dimensions	18" x 21"	18" x 27"
3" to 5"	9 (0206)	9 (0206)
6" to 8"	6 (0104)	6 (0104)
12"	4 (0102)	4 (0102)

SEE PAGE 224
KA, KD or MK

"R" Heavy-Duty Cabinets :

All models include a 2" recessed base and a central cabinet lock; Come with RA70 cabinet attachment bars to install the cabinet under the work surface;

The 12" drawer is designed to hold file hanging bars. Order RG30 or RG31 file bars.

SEE PAGE 189

Number of Compartments (layout code)				
Drawer Dimensions	24" x 21"	24" x 27"	30" x 21"	30" x 27"
3" to 5"	12 (0308)	20 (0316)	24 (0518)	25 (0420)
6" to 8"	9 (0206)	12 (0209)	12 (0308)	12 (0308)
9" and over	4 (0102)	6 (0104)	6 (0203)	9 (0206)

"L" Compact Cabinet 28" High – Without base



5 drawers

L3ABD-2861__ 18" x 21" x 28"
L3ABG-2861__ 18" x 27" x 28"



4 drawers

L3ABD-2871__ 18" x 21" x 28"
L3ABG-2871__ 18" x 27" x 28"



3 drawers

L3ABD-2873__ 18" x 21" x 28"
L3ABG-2873__ 18" x 27" x 28"



6 drawers

L3ABD-2867__ 18" x 21" x 28"
L3ABG-2867__ 18" x 27" x 28"



4 drawers

L3ABD-2869__ 18" x 21" x 28"
L3ABG-2869__ 18" x 27" x 28"

"L" Compact Cabinet 32" High – With 4" base



4 drawers

L3ABD-2851__C 18" x 21" x 32"
L3ABG-2851__C 18" x 27" x 32"



1 door / 1 adjustable shelf

L3ABD-2854__C 18" x 21" x 32"
L3ABG-2854__C 18" x 27" x 32"



3 drawers

L3ABD-2855__C 18" x 21" x 32"
L3ABG-2855__C 18" x 27" x 32"



2 drawers

L3ABD-2857__C 18" x 21" x 32"
L3ABG-2857__C 18" x 27" x 32"



4 drawers

L3ABD-2859__C 18" x 21" x 32"
L3ABG-2859__C 18" x 27" x 32"

"R" Heavy-Duty Cabinets – With 2" base



4 drawers

R5ACD-3013 24" x 21" x 32"
R5ACG-3013 24" x 27" x 32"



6 drawers

R5ACD-3017 24" x 21" x 32"
R5ACG-3017 24" x 27" x 32"



4 drawers

R5ADD-3015 30" x 21" x 32"
R5ADG-3015 30" x 27" x 32"



4 drawers

R5ADD-3017 30" x 21" x 32"
R5ADG-3017 30" x 27" x 32"



8 drawers

R5ADD-4409 30" x 21" x 46"
R5ADG-4409 30" x 27" x 46"

Components – Structure Under the Work Surface

Light-Duty Drawer Units

To order a drawer unit with locks on drawer, complete the part number with L3.

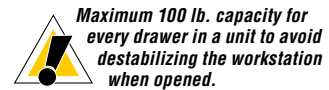
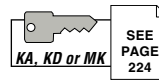

6" and 7" High Drawer Unit



1 drawer	1 drawer
LD77-3201__ 18" x 21" x 6"	LD77-3202__ 18" x 21" x 7"
LD77-4201__ 18" x 27" x 6"	LD77-4202__ 18" x 27" x 7"

9" High Drawer Unit



1 drawer	2 drawers
LD75-3201__ 18" x 21" x 9"	LD75-3202__ 18" x 21" x 9"
LD75-4201__ 18" x 27" x 9"	LD75-4202__ 18" x 27" x 9"

NOTE LD77 units are not stackable, and they are not compatible with LD76 covers.

12" High Drawer Unit

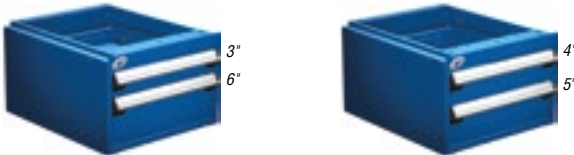

2 drawers	2 drawers
LD75-3203__ 18" x 21" x 12"	LD75-3204__ 18" x 21" x 12"
LD75-4203__ 18" x 27" x 12"	LD75-4204__ 18" x 27" x 12"

15" High Drawer Unit

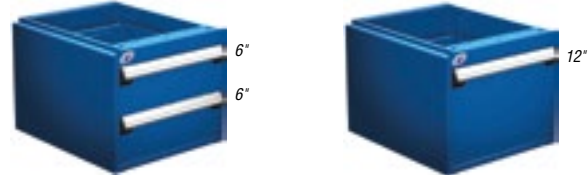

2 drawers	1 drawer
LD75-3206__ 18" x 21" x 15"	LD75-3207__ 18" x 21" x 15"
LD75-4206__ 18" x 27" x 15"	LD75-4207__ 18" x 27" x 15"

Heavy-Duty Drawer Units

To order a drawer unit with locks on drawer, complete the part number with L3.

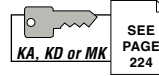

24" Width Drawer Unit



1 drawer	2 drawers
RD77-24210801__ 24" x 21" x 8"	RD77-24210802__ 24" x 21" x 8"
RD77-24270801__ 24" x 27" x 8"	RD77-24270802__ 24" x 27" x 8"

30" Width Drawer Unit



1 drawer	2 drawers
RD77-30210801__ 30" x 21" x 8"	RD77-30210802__ 30" x 21" x 8"
RD77-30270801__ 30" x 27" x 8"	RD77-30270802__ 30" x 27" x 8"

36" Width Drawer Unit

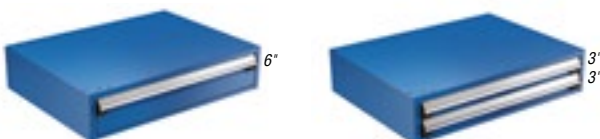

1 drawer	2 drawers
RD77-36240801__ 36" x 24" x 8"	RD77-36240802__ 36" x 24" x 8"
RD77-36270801__ 36" x 27" x 8"	RD77-36270802__ 36" x 27" x 8"

48" Width Drawer Unit

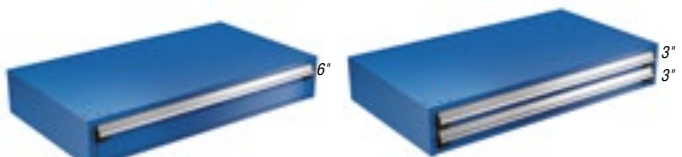

1 drawer	2 drawers
RD77-48240801__ 48" x 24" x 8"	RD77-48240802__ 48" x 24" x 8"
RD77-48270801__ 48" x 27" x 8"	RD77-48270802__ 48" x 27" x 8"