

HYDRAULIC POST TABLE - HT-40-4848

APPROX WEIGHT: 501.91 lbs.
DOES NOT INCLUDE WEIGHT OF POWER OR PACKAGING!!!

*** ANY ADDITIONS, DELETIONS, OR OMISSIONS MUST BE CORRECTED ON THIS DRAWING AS THIS DRAWING WILL BE CONSIDERED ALL INCLUSIVE ***

ALL GRAPHICS PROVIDED ARE FOR REFERENCE ONLY. IF CERTAIN DIMENSIONS ARE CRITICAL PLEASE VERIFY THOSE DIMENSIONS WITH YOUR SALESPERSON

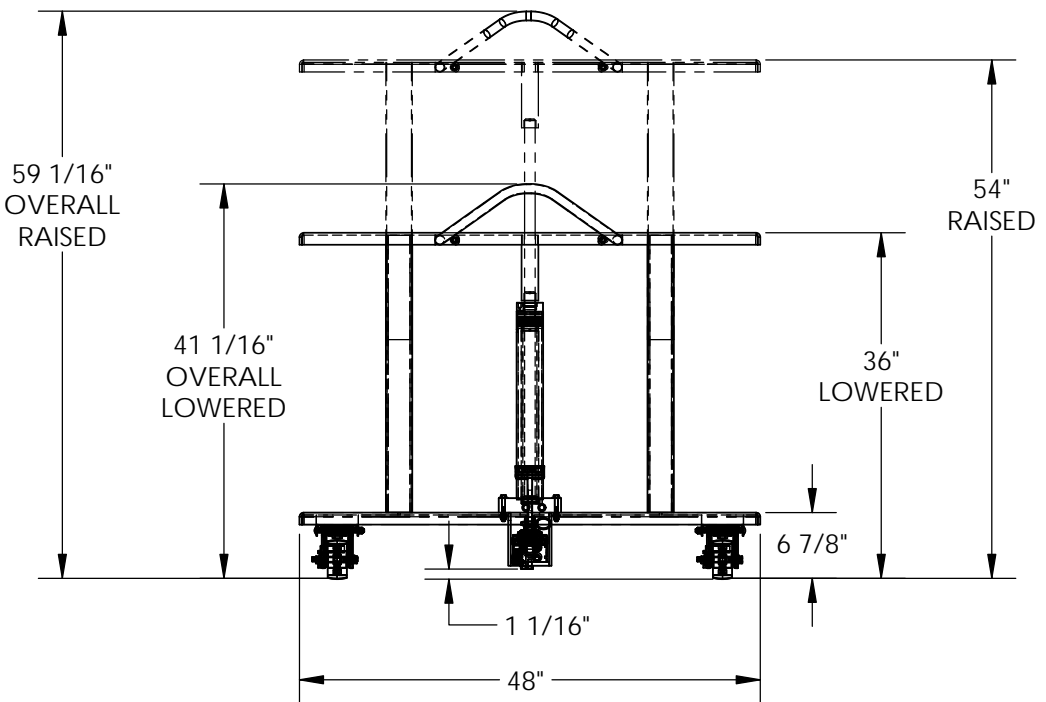
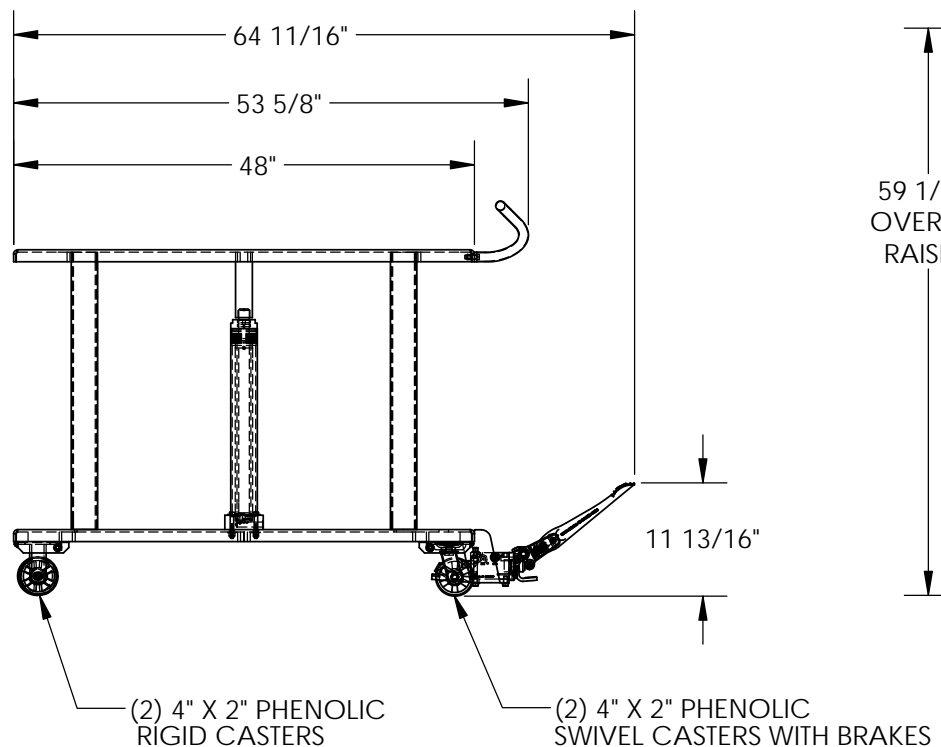

HYDRAULIC HOSES NOT SHOWN

STANDARD FEATURES

- MODEL NUMBER IS HT-40-4848
- MAX CAPACITY IS 4,000 LBS.
- OVERALL WIDTH IS 48"
- USABLE WIDTH IS 48"
- OVERALL LENGTH IS 64 11/16"
- USABLE LENGTH IS 48"
- RAISED HEIGHT IS 54"
- LOWERED HEIGHT IS 36"
- OVERALL RAISED HEIGHT IS 59 1/16"
- OVERALL LOWERED HEIGHT IS 41 1/16"
- (2) PHENOLIC RIGID CASTERS
- (2) PHENOLIC SWIVEL CASTERS WITH BRAKES

SPECIAL FEATURES

NONE

DIMENSION TOLERANCE ± 1/4"

APPROVAL	I, THE UNDERSIGNED, AGREE THAT THE PRODUCT AS REPRESENTED SATISFIES DESIGN AND DIMENSION REQUIREMENTS. I ALSO ACKNOWLEDGE MY DUTY TO CONFIRM PRODUCT AND INSTALLATION COMPLIANCE WITH ALL APPLICABLE FEDERAL, STATE AND LOCAL REGULATIONS AND STANDARDS.	
	ANY MODIFIED UNITS ARE NON-RETURNABLE	
	[] As drawn [] As marked	
	Signed: _____	Date: _____
Printed Name: _____		
<i>LEAD TIME WILL START UPON RECEIPT OF SIGNED APPROVAL DRAWING</i>		

FOR INTERNAL USE ONLY PROJECT SIGN OFF	
SALES	
ENG.	
FAB.	
POWER	

DISTRIBUTOR'S NAME:		P.O.#
VESTIL MANUFACTURING		X
DRAWN BY: TAW		W.O.#
DATE: 5/25/2016		X
REFERENCE: X	SCALE: 1:20	SALES: X
QUOTED LEAD TIME: X	QUOTE #	FILE NAME:
	X	21-007-112-002