



INDEX	PAGE(S)
R Heavy-Duty	
Modular Cabinet	4 - 5
Preconfigured Models	6 - 10
Accessories	11 - 18
Components	19 - 25
L Compact Cabinet	26
Preconfigured Models	
- Cabinets	27 - 28
- Drawer compartments	29 - 30
Accessories	31 - 35
Components	36 - 37

R HEAVY-DUTY MODULAR CABINET

Specially designed for intensive use, R Heavy-Duty Stationary Cabinets are the ideal solution for the diverse needs of our customers. They are market-leading products thanks to the wide range of dimensions and accessories available, their modular design and, above all, their durability.

Each of the 7 widths come in different depths for a total of 15 different work surface sizes. Each of these is available in 7 heights. And with 10 different drawer heights, you have an incredible choice of possible configurations to suit the intended purpose of the cabinet.

Rousseau's R cabinet was tested by an independent laboratory and proved to be the most durable on the market. The tests also showed the superiority of our drawers. This is why we proudly and confidently offer a lifetime warranty on the drawer rolling system.

The unique design of the R drawer is a trademark of Rousseau Metal Inc.

As well as being built for the toughest tasks, Rousseau cabinets boast stylish and distinctive aesthetics that stand the test of time: a timeless design, designed to last.



R5XEE-1006



Distributed by:
 Custom Equipment Company
 866-333-0728
 tom@custommhs.com
 www.custommhs.com

PRECONFIGURED MODELS

HERE ARE SOME OF OUR MOST POPULAR PRECONFIGURED MODELS OF THE R HEAVY-DUTY STATIONARY CABINETS

- The preconfigured models in this section include a 2"H front-access forklift base and a lock on the cabinet housing (models with more than one drawer) and on the door
- The doors are factory installed with hinges on the right-hand side. They can be installed on the left upon request
- To add an L50 electronic lock to a door or to your R cabinet, [see page 11](#)



NOTE: For interior drawer dimensions, [see pages 226-228](#).

IMPORTANT

Drawer compartments are included in all models. See the number of compartments and suggested layouts below.

For drawers without compartments, replace the last two digits of the model number with the next even number up

e.g., R5ACD-2801 with R5ACD-2802 without

NUMBER OF COMPARTMENTS (LAYOUT CODE)

DRAWER DIMENSIONS	3"H TO 5"H	6"H TO 8"H	9"H AND HIGHER
24"W x 21"D	12 (0308)	9 (0206)	4 (0102)
24"W x 27"D	20 (0316)	12 (0209)	6 (0104)
30"W x 21"D	24 (0518)	12 (0308)	6 (0203)
30"W x 27"D	25 (0420)	12 (0308)	9 (0206)
36"W x 18"D	24 (0518)	8 (0304)	6 (0203)
36"W x 24"D	30 (0524)	12 (0308)	9 (0206)
48"W x 24"D	40 (0732)	15 (0410)	8 (0304)
48"W x 27"D	32 (0724)	15 (0410)	8 (0304)
54"W x 24"D	40 (0930)	18 (0512)	10 (0405)
54"W x 27"D	40 (0930)	18 (0512)	10 (0405)
60"W x 24"D	70 (1356)	24 (0716)	12 (0308)
60"W x 27"D	84 (1370)	21 (0614)	12 (0308)

24" WIDE (W x D x H)



4 DRAWERS
R5ACD-2801 24" x 21" x 30"
R5ACG-2801 24" x 27" x 30"



4 DRAWERS
R5ACD-2813 24" x 21" x 30"
R5ACG-2813 24" x 27" x 30"



4 DRAWERS
R5ACD-2805 24" x 21" x 30"
R5ACG-2805 24" x 27" x 30"



6 DRAWERS
R5ACD-3001 24" x 21" x 32"
R5ACG-3001 24" x 27" x 32"



4 DRAWERS
R5ACD-3005 24" x 21" x 32"
R5ACG-3005 24" x 27" x 32"



1 DOOR /
1 ADJUSTABLE SHELF /
1 BOTTOM SHELF
R5ACD-3009 24" x 21" x 32"
R5ACG-3009 24" x 27" x 32"



3 DRAWERS
R5ACD-3405 24" x 21" x 36"
R5ACG-3405 24" x 27" x 36"



5 DRAWERS
R5ACD-3403 24" x 21" x 36"
R5ACG-3403 24" x 27" x 36"



9 DRAWERS
R5ACD-3805 24" x 21" x 40"
R5ACG-3805 24" x 27" x 40"



5 DRAWERS
R5ACD-3807 24" x 21" x 40"
R5ACG-3807 24" x 27" x 40"

30" WIDE (W x D x H)



5 DRAWERS
R5ADD-2801 30" x 21" x 30"
R5ADG-2801 30" x 27" x 30"



4 DRAWERS
R5ADD-2803 30" x 21" x 30"
R5ADG-2803 30" x 27" x 30"



5 DRAWERS
R5ADD-2805 30" x 21" x 30"
R5ADG-2805 30" x 27" x 30"



5 DRAWERS
R5ADD-3003 30" x 21" x 32"
R5ADG-3003 30" x 27" x 32"



6 DRAWERS
R5ADD-3007 30" x 21" x 32"
R5ADG-3007 30" x 27" x 32"

PRECONFIGURED MODELS



1 DRAWER / 1 DOOR /
1 BOTTOM SHELF
R5ADD-3009 30" x 21" x 32"
R5ADG-3009 30" x 27" x 32"



5 DRAWERS
R5ADD-3815 30" x 21" x 40"
R5ADG-3815 30" x 27" x 40"



7 DRAWERS
R5ADD-3803 30" x 21" x 40"
R5ADG-3803 30" x 27" x 40"



8 DRAWERS
R5ADD-4401 30" x 21" x 46"
R5ADG-4401 30" x 27" x 46"



5 DRAWERS
R5ADD-4411 30" x 21" x 46"
R5ADG-4411 30" x 27" x 46"



9 DRAWERS
R5ADD-5805 30" x 21" x 60"
R5ADG-5805 30" x 27" x 60"

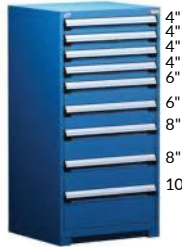

9 DRAWERS
R5ADD-5809 30" x 21" x 60"
R5ADG-5809 30" x 27" x 60"



6 DRAWERS
R5ADD-5843 30" x 21" x 60"
R5ADG-5843 30" x 27" x 60"



9 DRAWERS
R5ADD-5813 30" x 21" x 60"
R5ADG-5813 30" x 27" x 60"



1 DOOR /
1 BOTTOM SHELF / 5 DRAWERS
R5ADD-5845 30" x 21" x 60"
R5ADG-5845 30" x 27" x 60"

36" WIDE (W x D x H)



4 DRAWERS
R5AEC-2801 36" x 18" x 30"
R5AEE-2801 36" x 24" x 30"



4 DRAWERS
R5AEC-2803 36" x 18" x 30"
R5AEE-2803 36" x 24" x 30"



5 DRAWERS
R5AEC-3005 36" x 18" x 32"
R5AEE-3005 36" x 24" x 32"



2 DRAWERS
R5AEC-3021 36" x 18" x 32"
R5AEE-3021 36" x 24" x 32"



5 DRAWERS
R5AEC-3805 36" x 18" x 40"
R5AEE-3805 36" x 24" x 40"



5 DRAWERS
R5AEC-3807 36" x 18" x 40"
R5AEE-3807 36" x 24" x 40"



7 DRAWERS
R5AEC-4403 36" x 18" x 46"
R5AEE-4403 36" x 24" x 46"



11 DRAWERS
R5AEC-4405 36" x 18" x 46"
R5AEE-4405 36" x 24" x 46"



1 DOUBLE DOOR /
1 ADJUSTABLE SHELF /
1 BOTTOM SHELF
R5AEC-4412 36" x 18" x 46"
R5AEE-4412 36" x 24" x 46"



8 DRAWERS
R5AEC-4415 36" x 18" x 46"
R5AEE-4415 36" x 24" x 46"



11 DRAWERS
R5AEC-5803 36" x 18" x 60"
R5AEE-5803 36" x 24" x 60"



9 DRAWERS
R5AEC-5813 36" x 18" x 60"
R5AEE-5813 36" x 24" x 60"



6 DRAWERS
R5AEC-5859 36" x 18" x 60"
R5AEE-5859 36" x 24" x 60"



8 DRAWERS
R5AEC-5825 36" x 18" x 60"
R5AEE-5825 36" x 24" x 60"



7 DRAWERS
R5AEC-5861 36" x 18" x 60"
R5AEE-5861 36" x 24" x 60"

PRECONFIGURED MODELS

R CABINET

48" WIDE (W x D x H)



5 DRAWERS		
R5AHE-3003	48" x 24" x 32"	
R5AHG-3003	48" x 27" x 32"	



7 DRAWERS		
R5AHE-3801	48" x 24" x 40"	
R5AHG-3801	48" x 27" x 40"	



1 SLIDING DOOR / 1 ADJUSTABLE SHELF / 1 BOTTOM SHELF		
R5AHE-3803	48" x 24" x 40"	
R5AHG-3803	48" x 27" x 40"	



5 DRAWERS		
R5AHE-3807	48" x 24" x 40"	
R5AHG-3807	48" x 27" x 40"	



9 DRAWERS		
R5AHE-4405	48" x 24" x 46"	
R5AHG-4405	48" x 27" x 46"	



7 DRAWERS		
R5AHE-4407	48" x 24" x 46"	
R5AHG-4407	48" x 27" x 46"	



1 DOUBLE DOOR / 1 ADJUSTABLE SHELF / 1 BOTTOM SHELF		
R5AHE-4414	48" x 24" x 46"	
R5AHG-4414	48" x 27" x 46"	



5 DRAWERS		
R5AHE-4427	48" x 24" x 46"	
R5AHG-4427	48" x 27" x 46"	



15 DRAWERS		
R5AHE-5805	48" x 24" x 60"	
R5AHG-5805	48" x 27" x 60"	



6 DRAWERS		
R5AHE-5807	48" x 24" x 60"	
R5AHG-5807	48" x 27" x 60"	



8 DRAWERS		
R5AHE-5809	48" x 24" x 60"	
R5AHG-5809	48" x 27" x 60"	



9 DRAWERS		
R5AHE-5813	48" x 24" x 60"	
R5AHG-5813	48" x 27" x 60"	



54" WIDE (W x D x H)



6 DRAWERS
 R5AJE-3401 54" x 24" x 36"
 R5AJG-3401 54" x 27" x 36"



7 DRAWERS
 R5AJE-3403 54" x 24" x 36"
 R5AJG-3403 54" x 27" x 36"



5 DRAWERS
 R5AJE-3801 54" x 24" x 40"
 R5AJG-3801 54" x 27" x 40"



6 DRAWERS
 R5AJE-3803 54" x 24" x 40"
 R5AJG-3803 54" x 27" x 40"



5 DRAWERS / 1 ROLL-OUT SHELF
 R5AJE-4401 54" x 24" x 46"
 R5AJG-4401 54" x 27" x 46"



5 DRAWERS
 R5AJE-4405 54" x 24" x 46"
 R5AJG-4405 54" x 27" x 46"



7 DRAWERS
 R5AJE-4403 54" x 24" x 46"
 R5AJG-4403 54" x 27" x 46"



1 DOUBLE DOOR /
 3 ADJUSTABLE SHELVES /
 1 BOTTOM SHELF
 R5AJE-5802 54" x 24" x 60"
 R5AJG-5802 54" x 27" x 60"



8 DRAWERS
 R5AJE-5803 54" x 24" x 60"
 R5AJG-5803 54" x 27" x 60"

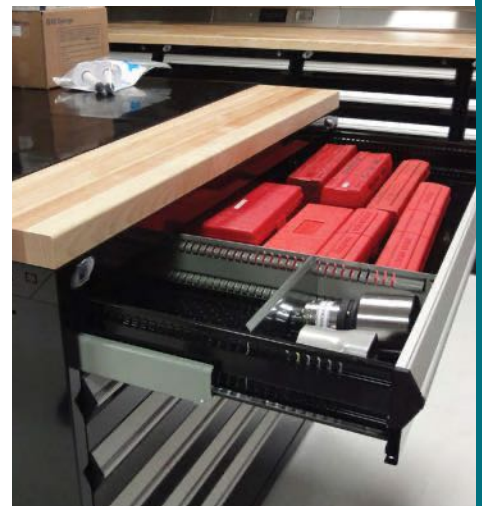

PRECONFIGURED MODELS

60" WIDE (W x D x H)



5 DRAWERS

R5AKE-3805	60" x 24" x 40"
R5AKG-3805	60" x 27" x 40"



7 DRAWERS

R5AKE-3807	60" x 24" x 40"
R5AKG-3807	60" x 27" x 40"



6 DRAWERS

R5AKE-4401	60" x 24" x 46"
R5AKG-4401	60" x 27" x 46"



1 SLIDING DOOR /
2 ADJUSTABLE SHELVES /
1 BOTTOM SHELF

R5AKE-4406	60" x 24" x 46"
R5AKG-4406	60" x 27" x 46"



5 DRAWERS / 1 ROLL-OUT SHELF

R5AKE-5801	60" x 24" x 60"
R5AKG-5801	60" x 27" x 60"



9 DRAWERS

R5AKE-5803	60" x 24" x 60"
R5AKG-5803	60" x 27" x 60"



SECURITY ACCESSORIES AND RECOMMENDATIONS

VERTICAL SECURITY BAR RB10



- Locks all drawers in a cabinet with a padlock on the right (A) or left (B)
- Safety hasp is located at the top of the bar to facilitate access
- Covers a bank of drawers from 20"H to 54"H
- Allows full access to drawers even when installed against a wall
- More than one bar on the same cabinet can be installed (for different users)
- To order: Specify which side the bar is to be installed on, e.g., RB10-20LPA for the right-hand side

PRODUCT NO.	HEIGHT
RB10-20LP_	20"
RB10-24LP_	24"
RB10-26LP_	26"
RB10-30LP_	30"
RB10-34LP_	34"
RB10-40LP_	40"
RB10-54LP_	54"

NOTE: Vertical security bar A is not compatible with a drawer lock

TRUE ONE-DRAWER-AT-A-TIME SYSTEM RB15



- Prevents multiple drawers from opening at the same time, which ensures the cabinet's stability and users' safety
- To order: Add A to the cabinet product number, e.g., RA30-302758A
- To retrofit this mechanism, order an RB15 and specify the number of drawers and roll-out shelves in the cabinet, e.g., RB15-58-07 for a cabinet with seven drawers
- One kit per cabinet

PRODUCT NO.	CABINET HEIGHT
RB15-28-__	28"
RB15-30-__	30"
RB15-34-__	34"
RB15-38-__	38"
RB15-44-__	44"
RB15-58-__	58"



Recommended for mobile cabinets and cabinets not anchored to the floor

SECURITY PANEL RF91



- Blocks access between two drawers with locks
- Usable space in the cabinet is reduced by 1"
- Installs between two drawers
- Divides the cabinet up for use by more than one user
- To order: Specify the width and depth required, e.g., RF91-3624 for a 36"W x 24"D panel

PRODUCT NO.
RF91-__ _

CENTRAL LOCKING SYSTEM L3



- Locks all drawers and roll-out shelves in the cabinet at the same time
- Drawer and roll-out shelf positions can be reconfigured
- Easy to retrofit
- To order: Add L3 to the cabinet product number, e.g., RA30-302758L3
- For replacement parts or to retrofit this mechanism, order an RB00-DDHHL3

PRODUCT NO.
L3



CABINET SAFETY HASP LP



- Locks all drawers and roll-out shelves in the cabinet at the same time
- Drawer and roll-out shelf positions can be reconfigured
- An alternative to an RB10 Vertical Security Bar
- Easy to retrofit
- To order: Add LP to the cabinet product number, e.g., RA30-302738LP
- For replacement parts or to retrofit this mechanism, order an RB00-DDHHL3

PRODUCT NO.
LP

ELECTRONIC LOCK FOR CABINET WITH DRAWERS L50



- Electronically locks all drawers in the cabinet at the same time
- No key required
- Up to 20 different users can be programmed
- 4- to 8-digit access codes
- Simplifies access management to drawers
- To order the complete mechanism with a cabinet with drawers, order an RB00-DDHHL50
- To order as a replacement lock, order an HA62-L50



PRODUCT NO.
L50

ELECTRONIC LOCK FOR DOORS L50



- Electronically locks a cabinet door
- No key required
- Up to 20 different users can be programmed
- 4- to 8-digit access codes
- Compatible with single, double and polycarbonate swing doors, with or without frame (RB61, RB62, RB67, RB66, RB75 and RB76)
- To order: Add L50 to the door product code, e.g. RB61-3620L50



PRODUCT NO.
L50

CABINET TOPS

STEEL TOP WITH RUBBER MAT

RC32



- ½"-thick non-slip neoprene surface
- Includes edges on the sides and back
- Height: 1"

LAMINATED HARDWOOD TOP

WS14



- Top for general industrial applications
- Made from varnished hardwood slats
- Includes a 90° radius front edge for extra comfort
- High impact resistance
- Attractive appearance
- Thickness: 1¾"

STAINLESS STEEL TOP

RC35



- 16ga stainless steel: RC35-WWDD
- 12ga stainless steel: RC35-WWDD-12
- Acts as a work surface and protects the cabinet from impacts
- Particle board top with stainless steel cover (#4 brushed finish)
- Excellent corrosion and chemical resistance
- Top complies with CARB regulations on formaldehyde emissions
- Includes welded corners for an attractive appearance
- Thickness: 1¾"
- To order a 12ga stainless steel top, add 12 to the product number

MARINE EDGE STAINLESS STEEL TOP

RC35



- Marine edge 16ga stainless steel: RC35-WWDD-16M
- Marine edge 12ga stainless steel: RC35-WWDD-12M
- Prevents small objects or liquids from falling or spilling from the work surface
- Acts as a work surface and protects the cabinet from impacts
- Particle board top with stainless steel cover (#4 brushed finish)
- Excellent corrosion and chemical resistance
- Top complies with CARB regulations on formaldehyde emissions
- Includes welded corners for an attractive appearance
- Thickness: 1¾"
- To order: Specify the steel gauge required, e.g., RC35-WWDD-16M for a marine edge 16ga stainless steel top

PAINTED STEEL TOP

RC37



- Acts as a work surface and protects the cabinet from impacts
- Particle board top with painted steel cover
- Top complies with CARB regulations on formaldehyde emissions
- Includes welded corners for an attractive appearance
- Thickness: 1¾"



DIMENSIONS		TYPE OF TOP				
W	D	STEEL TOP WITH RUBBER MAT	LAMINATED HARDWOOD TOP*	STAINLESS STEEL TOP	MARINE EDGE STAINLESS STEEL TOP*	PAINTED STEEL TOP
18"	21"	RC32-1821-01	WS14-1821A	RC35-1821-__**		RC37-1821
	27"	RC32-1827-01	WS14-1827A	RC35-1827-__**		RC37-1827
24"	21"	RC32-2421-01	WS14-2421A	RC35-2421-__**		RC37-2421
	27"	RC32-2427-01	WS14-2427A	RC35-2427-__		RC37-2427
30"	21"	RC32-3021-01	WS14-3021A	RC35-3021-__**		RC37-3021
	24"	RC32-3024-01	WS14-3027A	RC35-3024-__**		RC37-3024
	27"	RC32-3027-01	WS14-3027A	RC35-3027-__	RC35-3027-__M	RC37-3027
	30"	RC32-3030-01	WS14-3030A	RC35-3030-__	RC35-3030-__M	RC37-3030
36"	18"	RC32-3618-01	WS14-3618A			RC37-3618
	21"	RC32-3621-01	WS14-3621A	RC35-3621-__**		RC37-3621
	24"	RC32-3624-01	WS14-3624A	RC35-3624-__	RC35-3624-__M	RC37-3624
	27"	RC32-3627-01	WS14-3627A	RC35-3627-__	RC35-3627-__M	RC37-3627
	30"	RC32-3630-01	WS14-3630A	RC35-3630-__	RC35-3630-__M	RC37-3630
48"	24"	RC32-4824-01	WS14-4824A	RC35-4824-__	RC35-4824-__M	RC37-4824
	27"	RC32-4827-01	WS14-4827A	RC35-4827-__	RC35-4827-__M	RC37-4827
	30"	RC32-4830-01	WS14-4830A	RC35-4830-__	RC35-4830-__M	RC37-4830
54"	24"	RC32-5424-01	WS14-5424A	RC35-5424-__	RC35-5424-__M	RC37-5424
	27"	RC32-5427-01	WS14-5427A	RC35-5427-__	RC35-5427-__M	RC37-5427
	30"	RC32-5430-01	WS14-5430A	RC35-5430-__	RC35-5430-__M	RC37-5430
60"	24"	RC32-6024-01	WS14-6024A	RC35-6024-__	RC35-6024-__M	RC37-6024
	27"	RC32-6027-01	WS14-6027A	RC35-6027-__	RC35-6027-__M	RC37-6027
	30"	RC32-6030-01	WS14-6030A	RC35-6030-__	RC35-6030-__M	RC37-6030
72"	24"	RC32-7224-01	WS14-7224A	RC35-7224-__	RC35-7224-__M	RC37-7224
	27"	RC32-7227-01	WS14-7227A	RC35-7227-__	RC35-7227-__M	RC37-7227
	30"	RC32-7230-01	WS14-7230A	RC35-7230-__	RC35-7230-__M	RC37-7230

NOTES: * Please check with your Customer Service representative for lead times.

** 16ga only

For compatibility with doors with frame, choose a top 3" deeper than your cabinet, e.g., 27"D cabinet + door with 3"D frame = 30"D top

SLOPED TOP

RC30

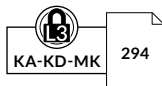

- The 30° sloped surface opens so documents and other items can be stored inside
- Compatible with a ½" dia. articulated lamp
- Load capacity: 100lb. (evenly distributed)
- For compatibility with doors with frame, choose a top 3" deeper than your cabinet, e.g., 27"D cabinet + door with 3"D frame = 30"D top
- Standard lock included

PRODUCT NO.	W x D x H	COMPATIBLE DIVIDER
RC30-242708L3	24" x 27" x 8"	SH52-1506
RC30-302708L3	30" x 27" x 8"	SH52-1506
RC30-303008L3	30" x 30" x 8"	SH52-1806
RC30-362408L3	36" x 24" x 8"	SH52-1206
RC30-362708L3	36" x 27" x 8"	SH52-1506
RC30-363008L3	36" x 30" x 8"	SH52-1806
RC30-482408L3	48" x 24" x 8"	SH52-1206
RC30-482708L3	48" x 27" x 8"	SH52-1506
RC30-483008L3	48" x 30" x 8"	SH52-1806

PARTIAL DIVIDER

SH52



- Unique patented design for easy position changes
- Height: 5½"
- Easy tool-free installation

Dimensions for sloped tops

PRODUCT NO.	ACTUAL DEPTH	FOR RC30
SH52-1206	7½"	24" Deep
SH52-1506	10½"	27" Deep
SH52-1806	13½"	30" Deep

Dimensions for RB shelves

PRODUCT NO.	ACTUAL DEPTH	FOR SHELVES
SH52-1506	10½"	18" Deep
SH52-1806	13½"	21" Deep
SH52-2106	16½"	24" Deep
SH52-2406	19½"	27" Deep

Includes pictograms for easy installation

NOTE: Requires a minimum space of 8" between shelves.

ACCESSORIES

BACK OR SIDE STOP

WS18 / WS98



- Painted steel: WS18
- Stainless steel: WS98
- Can be installed on back or sides depending on top dimensions
- Installs on WS14 and RC37 tops
- Height: 5"
- Clears top by approx. 3 1/4"
- To order: Add the type of steel required to the product number

PRODUCT NO.	LENGTH
WS__-1805	18"
WS__-2405	24"
WS__-2705	27"
WS__-3005	30"
WS__-3605	36"
WS__-4805	48"
WS__-5405	54"
WS__-6005	60"
WS__-7205	72"

NOTE: Not compatible with RC32 and RC35 tops.



STACKING CABINETS

STACKING CABINETS



- One shelf, adjustable in 1" increments c/c
- One bottom shelf
- Standard lock included on each door
- Heights available: 24", 30" and 34"
- Includes hardware kit for stacking
- To order: Specify the cabinet height and door type required according to the chart, e.g., R5HEE-2403 for a 36"W x 24"D x 24"H cabinet with double integrated doors

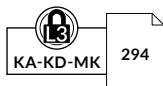

PRODUCT NO.	W x D
R5HBD-___	18" x 21"
R5HBG-___	18" x 27"
R5HCD-___	24" x 21"
R5HCG-___	24" x 27"
R5HDD-___	30" x 21"
R5HDG-___	30" x 27"
R5HEC-___	36" x 18"
R5HEE-___	36" x 24"

PRODUCT NO.	W x D
R5HEG-___	36" x 27"
R5HHE-___	48" x 24"
R5HHG-___	48" x 27"
R5HJE-___	54" x 24"
R5HJG-___	54" x 27"
R5HKE-___	60" x 24"
R5HKG-___	60" x 27"



R5XHE-1002

DOOR REQUIRED	CABINET WIDTH				
	18" & 24"	30" & 36"	48"	54"	60"
00 Without door	X	X	X	X	X
01 Single integrated door	X	X			
02 Single integrated polycarbonate door	X	X			
03 Double integrated doors		X	X	X	X
04 Double integrated polycarbonate doors		X	X	X	X
05 Double doors with frame		X	X	X	X
06 Double polycarbonate doors with frame		X	X	X	X
07 Integrated sliding doors			X	X	X
08 Integrated sliding polycarbonate doors			X	X	X
09 Sliding doors with frame			X		X
10 Sliding polycarbonate doors with frame			X		X



POWER FEED PANELS AND COVER PANELS

PANEL	FINISH	
	PAINTED STEEL	STAINLESS STEEL
Power feed	RC64	RC65
Finishing	RC66	RC67
Finishing panel for computer mount	RC68	RC69

BACK PANEL	PRODUCT NO.	ENDS WITH
Without	01	
With	02	

POWER FEED PANEL

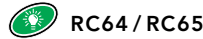

- Painted steel: RC64
- Stainless steel: RC65
- Includes a power bar with three 12A outlets for a 15A circuit
- Three additional versions available: with a knockout for a pneumatic connection and a perforation (with a cover plate) for a telephone/Ethernet jack; or with two USB ports; or with knockout, perforation and two USB ports
- Installs on RC35, RC37, WS08, WS14 and WS16 tops only
- To order: Specify the panel width required: 30", 36", 48", 54", 60", 72" e.g., RC64-301001 for a 30"W panel
- To order: Specify with or without a back finishing panel: Without: 01 With: 02 e.g., RC64-301001 without back finishing panel

PRODUCT NO.	OPTIONS
RC64-__10__	3 power outlets (12A)
RC64-__11__	3 power outlets (12A) and perforation
RC64-__12__	3 power outlets (12A), 2 USB ports (1 A, 1 C)
RC64-__13__	3 power outlets (12A), 2 USB ports (1 A, 1 C), knockout and perforation
RC65-__10__	3 power outlets (12A)
RC65-__11__	3 power outlets (12A) and perforation
RC65-__12__	3 power outlets (12A), 2 USB ports (1 A, 1 C)
RC65-__13__	3 power outlets (12A), 2 USB ports (1 A, 1 C), knockout and perforation



Pneumatic connection



USB ports



Phone/Ethernet jacks



R5XHG-1056

COVER PANEL FOR COMPUTER MOUNT

RC68 / RC69



- Painted steel: RC68
- Stainless steel: RC69
- Can be combined with a power feed panel or a cover panel on the same workstation or cabinet
- To order: Specify the type of finish required, e.g., RC68-2401 for painted steel
- Available with or without a back finishing panel
- Installs on RC35, RC37, WS08, WS14 and WS16 tops only
- Includes a perforation in the middle for installation of RC59 computer mounts

PRODUCT NO.	WIDTH	WITH OR WITHOUT BACK PANEL
RC__-1801	18"	Without back panel
RC__-1802	18"	With back panel
RC__-2401	24"	Without back panel
RC__-2402	24"	With back panel

COVER PANEL

RC66 / RC67



- Painted steel: RC66
- Stainless steel: RC67
- Can be combined with a power feed panel or a cover panel, on the same workstation or cabinet
- Available with or without a back finishing panel
- Installs on RC35, RC37, WS08, WS14 and WS16 tops only
- To order: Specify the type of finish required, e.g., RC66-3001 for painted steel

PRODUCT NO.	WIDTH	WITH OR WITHOUT BACK PANEL
RC__-1801	18"	Without back panel
RC__-1802	18"	With back panel
RC__-2401	24"	Without back panel
RC__-2402	24"	With back panel
RC__-3001	30"	Without back panel
RC__-3002	30"	With back panel
RC__-3601	36"	Without back panel
RC__-3602	36"	With back panel
RC__-4801	48"	Without back panel
RC__-4802	48"	With back panel
RC__-5401	54"	Without back panel
RC__-5402	54"	With back panel
RC__-6001	60"	Without back panel
RC__-6002	60"	With back panel
RC__-7201	72"	Without back panel
RC__-7202	72"	With back panel

ACCESSORIES

COMPUTER MOUNTS

All models featured here have the following characteristics:

- Installs on the work surface with an RC68 or RC69 cover panel for computer mounts
- Compatible with the following work surfaces: WS08, WS14, WS16, RC35 and RC37
- Includes an 18"H pole for height adjustment to suit each user

- The work surface must extend beyond the rear by 1½"
- Articulating arms, adapters and trays are painted black
- Does not install directly on the housing

LCD MONITOR ARM



- Supports most LCD monitors on the market (max. 21")
- Includes one or two arms with two-section articulation
- Complies with VESA 75 and 100 monitor mounting standards
- The two-section articulating arm allows for increased adjustability
- The screen can also be tilted for better ergonomics
- One or two arms can be ordered

PRODUCT NO.	FOR
RC59-03	Single screen
RC59-04	Two screens

LAPTOP ARM



- Holds a laptop computer, papers, binders or any other object
- Tray's usable area: 14"W x 12"D
- Includes a two-section articulating arm and a tray
- The two-section articulating arm allows for increased adjustability
- The tray can also be tilted for better ergonomics

PRODUCT NO.
RC59-42

LCD MONITOR, KEYBOARD & MOUSE MOUNT



- Holds a computer monitor, keyboard and mouse
- Tray's usable area: 23½"W x 8½"D
- Includes an articulating arm and tray for a keyboard, and mount for a screen
- Complies with VESA 75 and 100 monitor mounting standards
- Supports most LCD monitors on the market (max. 21")
- The tray and screen can also be tilted for better ergonomics

PRODUCT NO.
RC59-21

TABLET ARM



- Supports most tablets on the market
- Includes a two-section articulating arm and a tablet mount
- The clamps and mount have a non-slip surface to keep the tablet stable
- The two-section articulating arm allows for increased adjustability
- The mount can also be tilted for better ergonomics
- Compatible tablet sizes:
 - Small: 7¾"W to 10"W
 - Large: 9¾"W to 12¼"W

PRODUCT NO.	FOR
RC59-62-01	Small
RC59-62-02	Large



SIDE PANELS

SIDE UTILITY PANEL

RC02

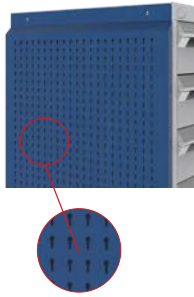

- 5S storage accessory
- Maximizes the cabinet's storage space
- Installs on the sides of R cabinets
- Quick and easy installation
- Includes perforations spaced 1" apart c/c for hanging a range of hooks
- Load capacity: 50lb./sq. ft., 500lb. max. per panel
- Compatible with WM9F, WM9G, WM9H, WM9J and WM9L light-duty hooks, and WM9A and WM9B heavy-duty hooks
- Compatible with WM9Q tool holders, WM9C bin rails, WM9D can holders, WM9M and WM9N hooks, WM9P spool and roll holders, and WM21 shelves
- Available in all standard R cabinet dimensions (depth, height)
- To order: Specify the housing height required, e.g., RC02-2434 for a 24"D x 34"H housing

PRODUCT NO.	CABINET DEPTH	NO. OF HOLES
RC02-18 __	18"	15
RC02-21 __	21"	18
RC02-24 __	24"	21
RC02-27 __	27"	24

NOTE: Full height installation only.

SIDE PANEL FOR PLASTIC BINS

RC04

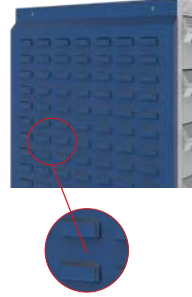

- 5S storage accessory
- Maximizes the cabinet's storage space
- Installs on the sides of R cabinets
- Quick and easy installation
- Holds RG20 plastic bins
- Compatible with all commercially available brands of plastic bins with a hanging lip
- Available in all standard R cabinet dimensions (depth, height)
- To order: Specify the housing height required: RC04-2434 for a 24"D x 34"H housing

PRODUCT NO.	CABINET DEPTH
RC04-18 __	18"
RC04-21 __	21"
RC04-24 __	24"
RC04-27 __	27"

NOTE: Full height installation only.

ESD PROTECTION

ESD CABINET

RC50



- Special paint dissipates electric charges (Black 090)
- Includes a grounding cord with 1MΩ resistance and a socket for a grounding wrist strap
- To order a cabinet with ESD protection, please order an RC50-01 grounding kit and specify dissipative paint color Black 090

PRODUCT NO.
RC50-01



NOTE: Contact Customer Service for ESD paint prices.

GROUNDING WRIST STRAP



- Made of stretch fabric
- Includes a 6" cord with 1MΩ resistance
- Dissipates electric charges that can damage electronic components

PRODUCT NO.
70000320

CONDUCTIVE PLASTIC BINS



245

DISSIPATIVE TOP



144

ACCESSORIES

WASTE & RECYCLING CABINETS AND SINK CABINET

WASTE & RECYCLING CABINET



- Can be used as a standalone unit, as part of a cabinet configuration (e.g., counter cabinets) or integrated underneath a work surface
- Used for sorting waste and items for recycling
- Includes one 26"H drawer with labeled drawer handle to facilitate sorting

- Includes two 15¼"W × 11"D × 20"H containers: a black container for waste (RK09-02) and a blue container for recycling (RK09-01)
- The drawer includes a divider which secures the containers and also allows items to be stored behind

PRODUCT NO.	W × D × H
R5XCG-1100	24" × 27" × 30"
R5XDG-1100	30" × 27" × 30"

WASTE & RECYCLING DRAWER



- Used for sorting waste and items for recycling
- Includes a labeled drawer handle to facilitate sorting
- Drawer heights available: 17" and 26"
- The 17"H drawer includes two 14¾"W × 10¼"D × 15"H containers: a black container for waste and a blue container for recycling
- The 26"H drawer includes two 15¼"W × 11"D × 20"H containers: a black container for waste and a blue container for recycling

- The drawer includes a divider which secures the containers and also allows items to be stored behind
- To add a locking or security mechanism, complete the product number with the locking mechanism product number required, e.g., R51CG-X1701A to add an integrated lock-in mechanism

PRODUCT NO.	W × D × H
R51CG-X1701_	24" × 27" × 17"
R51CG-X2601_	24" × 27" × 26"
R51DG-X1701_	30" × 27" × 17"
R51DG-X2601_	30" × 27" × 26"

NOTE: The drawer is also available separately; see RF53 for a painted steel front and RF54 for a stainless steel front

SINK CABINET



- The top is open to allow for installation of a sink
- Includes an opening on the back of the housing to allow for installation of a drain and pipes
- One bottom shelf
- Models with a door with frame are compatible with drawers and roll-out shelves
- Standard lock included on each door
- Compatible with bases, [see page 20](#)

- Heights available: 28", 30" and 34"
- To order: Specify the cabinet height and door type required according to the chart below, e.g., R5TDD-28 01

PRODUCT NO.	W × D	DOOR REQUIRED
R5TCD-___*	24" × 21"	01 Single integrated door
R5TCG-___*	24" × 27"	02 Double integrated doors
R5TDD-___**	30" × 21"	03 Double doors with frame
R5TDG-___**	30" × 27"	04 Integrated sliding doors
R5THD-___	48" × 21"	05 Sliding doors with frame
R5THG-___	48" × 27"	

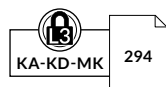

NOTES: ** Available with single door only

** These models are not compatible with sliding doors

Work surfaces must be ordered separately (work surface cutting is not provided by Rousseau), [see page 12 and 144](#).

Sink not included.



R5XTG-3002

HOUSINGS

R HEAVY-DUTY CABINET HOUSING

RA30

- Compatible with modular drawers, roll-out shelves, adjustable shelves and bottom shelves
- Compatible with integrated doors and doors with frame
- The housing units include knockouts
 - on the top for stacking cabinets and installing accessories or work surfaces
 - on the sides and back for anchoring cabinets side by side or back to back and for attaching accessories
- Includes a concrete-floor anchoring kit for cabinet housings and bases, and hardware for stacking cabinets

- A cabinet lock allows users to lock all drawers and roll-out shelves in the cabinet at the same time. To order, add **L3** to the product number, [see page 11](#);
- To order a safety hasp, add **LP** to the product number, [see page 11](#)
- For factory installation of an electronic lock, order a **RB00-DDHHL50**, [see page 11](#);
- To order a true One-Drawer-at-a-Time mechanism, add **A** to the product number

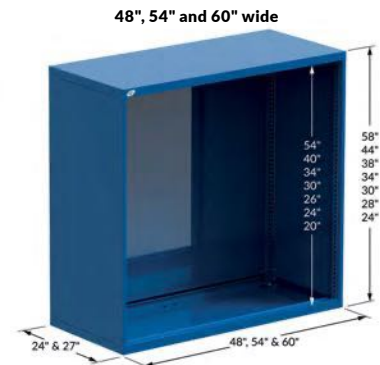
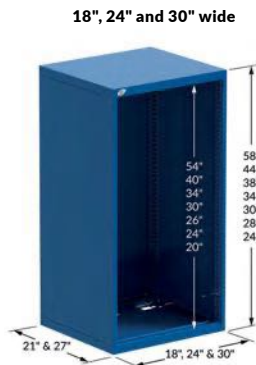
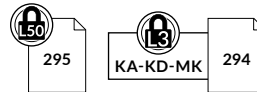

PRODUCT NO.	TOTAL HEIGHT	INSIDE HEIGHT
18" x 21"		
RA30-182124__	24"	20"
RA30-182128__	28"	24"
RA30-182130__	30"	26"
RA30-182134__	34"	30"
RA30-182138__	38"	34"
RA30-182144__	44"	40"
RA30-182158__	58"	54"
18" x 27"		
RA30-182724__	24"	20"
RA30-182728__	28"	24"
RA30-182730__	30"	26"
RA30-182734__	34"	30"
RA30-182738__	38"	34"
RA30-182744__	44"	40"
RA30-182758__	58"	54"
24" x 21"		
RA30-242124__	24"	20"
RA30-242128__	28"	24"
RA30-242130__	30"	26"
RA30-242134__	34"	30"
RA30-242138__	38"	34"
RA30-242144__	44"	40"
RA30-242158__	58"	54"
24" x 27"		
RA30-242724__	24"	20"
RA30-242728__	28"	24"
RA30-242730__	30"	26"
RA30-242734__	34"	30"
RA30-242738__	38"	34"
RA30-242744__	44"	40"
RA30-242758__	58"	54"

PRODUCT NO.	TOTAL HEIGHT	INSIDE HEIGHT
30" x 21"		
RA30-302124__	24"	20"
RA30-302128__	28"	24"
RA30-302130__	30"	26"
RA30-302134__	34"	30"
RA30-302138__	38"	34"
RA30-302144__	44"	40"
RA30-302158__	58"	54"
30" x 27"		
RA30-302724__	24"	20"
RA30-302728__	28"	24"
RA30-302730__	30"	26"
RA30-302734__	34"	30"
RA30-302738__	38"	34"
RA30-302744__	44"	40"
RA30-302758__	58"	54"
36" x 18"		
RA30-361824__	24"	20"
RA30-361828__	28"	24"
RA30-361830__	30"	26"
RA30-361834__	34"	30"
RA30-361838__	38"	34"
RA30-361844__	44"	40"
RA30-361858__	58"	54"
36" x 24"		
RA30-362424__	24"	20"
RA30-362428__	28"	24"
RA30-362430__	30"	26"
RA30-362434__	34"	30"
RA30-362438__	38"	34"
RA30-362444__	44"	40"
RA30-362458__	58"	54"

PRODUCT NO.	TOTAL HEIGHT	INSIDE HEIGHT
36" x 27"		
RA30-362724__	24"	20"
RA30-362728__	28"	24"
RA30-362730__	30"	26"
RA30-362734__	34"	30"
RA30-362738__	38"	34"
RA30-362744__	44"	40"
RA30-362758__	58"	54"
48" x 24"		
RA30-482424__	24"	20"
RA30-482428__	28"	24"
RA30-482430__	30"	26"
RA30-482434__	34"	30"
RA30-482438__	38"	34"
RA30-482444__	44"	40"
RA30-482458__	58"	54"
48" x 27"		
RA30-482724__	24"	20"
RA30-482728__	28"	24"
RA30-482730__	30"	26"
RA30-482734__	34"	30"
RA30-482738__	38"	34"
RA30-482744__	44"	40"
RA30-482758__	58"	54"
54" x 24"		
RA30-542424__	24"	20"
RA30-542428__	28"	24"
RA30-542430__	30"	26"
RA30-542434__	34"	30"
RA30-542438__	38"	34"
RA30-542444__	44"	40"
RA30-542458__	58"	54"

PRODUCT NO.	TOTAL HEIGHT	INSIDE HEIGHT
54" x 27"		
RA30-542724__	24"	20"
RA30-542728__	28"	24"
RA30-542730__	30"	26"
RA30-542734__	34"	30"
RA30-542738__	38"	34"
RA30-542744__	44"	40"
RA30-542758__	58"	54"
60" x 24"		
RA30-602424__	24"	20"
RA30-602428__	28"	24"
RA30-602430__	30"	26"
RA30-602434__	34"	30"
RA30-602438__	38"	34"
RA30-602444__	44"	40"
RA30-602458__	58"	54"
60" x 27"		
RA30-602724__	24"	20"
RA30-602728__	28"	24"
RA30-602730__	30"	26"
RA30-602734__	34"	30"
RA30-602738__	38"	34"
RA30-602744__	44"	40"
RA30-602758__	58"	54"

BASES

FRONT ACCESS FORKLIFT BASE RA52



- 2"H base used for moving the cabinet from the front with a forklift
- Includes a front kick plate
- Front kick plate is recessed to allow users to stand closer to the cabinet
- Designed so the cabinet can be anchored to the floor
- Compatible with RA74 Leveling Glide Kit
- Compatible with an optional RA54 Angled Kick Plate

PRODUCT NO.	W × D
RA52-182102	18" × 21"
RA52-182702	18" × 27"
RA52-242102	24" × 21"
RA52-242702	24" × 27"
RA52-302102	30" × 21"
RA52-302702	30" × 27"
RA52-361802	36" × 18"
RA52-362402	36" × 24"

PRODUCT NO.	W × D
RA52-362702	36" × 27"
RA52-482402	48" × 24"
RA52-482702	48" × 27"
RA52-542402	54" × 24"
RA52-542702	54" × 27"
RA52-602402	60" × 24"
RA52-602702	60" × 27"

NOTES: Not compatible with casters
Not to be used for stacking cabinets

FRONT AND SIDE ACCESS FORKLIFT BASE RA53



- 4"H base used for moving the cabinet from the front or side with a forklift, or from the front with a pallet-jack
- Includes a front kick plate
- Includes a recessed kick plate in the center to allow users to stand closer to the cabinet
- Designed so the cabinet can be anchored to the floor
- Compatible with RA74 Leveling Glide Kit
- Compatible with an optional RA54 Angled Kick Plate

PRODUCT NO.	W × D
RA53-182104	18" × 21"
RA53-182704	18" × 27"
RA53-242104	24" × 21"
RA53-242704	24" × 27"
RA53-302104	30" × 21"
RA53-302704	30" × 27"
RA53-361804	36" × 18"
RA53-362404	36" × 24"

PRODUCT NO.	W × D
RA53-362704	36" × 27"
RA53-482404	48" × 24"
RA53-482704	48" × 27"
RA53-542404	54" × 24"
RA53-542704	54" × 27"
RA53-602404	60" × 24"
RA53-602704	60" × 27"

NOTES: Not compatible with casters
Not to be used for stacking cabinets

ANGLED KICK PLATE RA54



- Closes off the back of 2"H and 4"H forklift bases (RA52 and RA53)

PRODUCT NO.	W × H
RA54-1802	18" × 2"
RA54-1804	18" × 4"
RA54-2402	24" × 2"
RA54-2404	24" × 4"
RA54-3002	30" × 2"
RA54-3004	30" × 4"
RA54-3602	36" × 2"
RA54-3604	36" × 4"
RA54-4802	48" × 2"
RA54-4804	48" × 4"
RA54-5402	54" × 2"
RA54-5404	54" × 4"
RA54-6002	60" × 2"
RA54-6004	60" × 4"

RECESSED BASE RA55 / RA57



- Painted steel: RA55
- Stainless steel: RA57
- Raises the height of a cabinet by 2" or 4"
- Includes a removable kick plate at the front for a neater finish
- The front kick plate is on a straight angle for easier floor cleaning
- Creates a 2" recessed space to allow users to stand closer to the cabinet
- Designed so the cabinet can be anchored to the floor
- Compatible with an optional RA56 or RA58 Straight Kick Plate
- Compatible with RA74 Leveling Glide Kit
- To order: Add the type of steel required to the product number e.g., RA57-302702 for 30"W × 27"D × 2"H stainless steel base
- For a replacement front kick plate, order an RY75-LLHH (painted steel) or RY77-WVHH (stainless steel).

PRODUCT NO.	W × D × H
RA__-182102	18" × 21" × 2"
RA__-182104	18" × 21" × 4"
RA__-182702	18" × 27" × 2"
RA__-182704	18" × 27" × 4"
RA__-242102	24" × 21" × 2"
RA__-242104	24" × 21" × 4"
RA__-242702	24" × 27" × 2"
RA__-242704	24" × 27" × 4"
RA__-302102	30" × 21" × 2"
RA__-302104	30" × 21" × 4"
RA__-302702	30" × 27" × 2"
RA__-302704	30" × 27" × 4"
RA__-361802	36" × 18" × 2"
RA__-361804	36" × 18" × 4"
RA__-362402	36" × 24" × 2"
RA__-362404	36" × 24" × 4"
RA__-362702	36" × 27" × 2"
RA__-362704	36" × 27" × 4"

PRODUCT NO.	W × D × H
RA__-482402	48" × 24" × 2"
RA__-482404	48" × 24" × 4"
RA__-482702	48" × 27" × 2"
RA__-482704	48" × 27" × 4"
RA__-542402	54" × 24" × 2"
RA__-542404	54" × 24" × 4"
RA__-542702	54" × 27" × 2"
RA__-542704	54" × 27" × 4"
RA__-602402	60" × 24" × 2"
RA__-602404	60" × 24" × 4"
RA__-602702	60" × 27" × 2"
RA__-602704	60" × 27" × 4"

NOTES: Not compatible with casters
Not to be used for stacking cabinet

STRAIGHT KICK PLATE

RA56 / RA58



- Painted steel: RA56
- Stainless steel: RA58
- Closes off the back of 2"H and 4"H recessed bases (RA55 and RA57)
- To order: Add the type of steel required to the product number, e.g., RA58-4804 for a 48"W x 4"H stainless steel straight kick plate

PRODUCT NO.	W x H
RA__-1802	18" x 2"
RA__-1804	18" x 4"
RA__-2402	24" x 2"
RA__-2404	24" x 4"
RA__-3002	30" x 2"
RA__-3004	30" x 4"
RA__-3602	36" x 2"
RA__-3604	36" x 4"
RA__-4802	48" x 2"
RA__-4804	48" x 4"
RA__-5402	54" x 2"
RA__-5404	54" x 4"
RA__-6002	60" x 2"
RA__-6004	60" x 4"

LEVELING GLIDE KIT

RA74



- Sold in kits of 4
- Adjusts the height of cabinets 1 1/8" to 2" on uneven floor surfaces

PRODUCT NO.
RA74-01

SHIM PLATE

RA80



- Sold individually
- Levels cabinets on uneven surfaces
- Compatible with floor anchoring kits
- 12ga galvanized steel

PRODUCT NO. THICKNESS:
RA80-12 12 gauge (0,100)

DRAWERS, SHELVES AND LOCKING / SECURITY MECHANISMS

HEAVY-DUTY MODULAR DRAWER

 RF31 / RF35

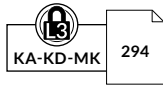

- Painted steel drawer: RF31
- Drawer with stainless steel front and gray painted steel interior: RF35
- 400lb. load capacity, 100% extension
- Heavy-duty construction
- Easy to install
- Vast choice of accessories available to customize the drawer to your storage needs, [see pages 242-247](#)
- Drawer heights available: 3", 4", 5", 6", 7", 8", 9", 10", 12" and 14"
- To order: Add the drawer height to the product number and specify the type of drawer front required (painted steel or stainless steel), e.g., RF31-362406
- For preconfigured modular drawers with compartments, [see pages 224-241](#)

PRODUCT NO.	W x D
RF__-1821__	18" x 21"
RF__-1827__	18" x 27"
RF__-2421__	24" x 21"
RF__-2427__	24" x 27"
RF__-3021__	30" x 21"
RF__-3027__	30" x 27"
RF__-3618__	36" x 18"
RF__-3624__	36" x 24"
RF__-3627__	36" x 27"
RF__-4824__	48" x 24"
RF__-4827__	48" x 27"
RF__-5424__	54" x 24"
RF__-5427__	54" x 27"
RF__-6024__	60" x 24"
RF__-6027__	60" x 27"

HEAVY-DUTY FRONT ACCESS ROLL-OUT SHELF

 RF40



- 400lb. load capacity, 100% extension
- Heavy-duty construction
- Easy to install
- Painted steel with 3"H edges on the sides and back
- Total height: 6"
- Full access to contents

PRODUCT NO.	W x D	PRODUCT NO.	W x D
RF40-1821	18" x 21"	RF40-4824	48" x 24"
RF40-1827	18" x 27"	RF40-4827	48" x 27"
RF40-2421	24" x 21"	RF40-5424	54" x 24"
RF40-2427	24" x 27"	RF40-5427	54" x 27"
RF40-3021	30" x 21"	RF40-6024	60" x 24"
RF40-3027	30" x 27"	RF40-6027	60" x 27"
RF40-3618	36" x 18"		
RF40-3624	36" x 24"		
RF40-3627	36" x 27"		

HEAVY-DUTY 3-SIDED ACCESS ROLL-OUT SHELF

 RF44

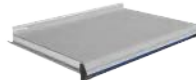

- 400lb. load capacity, 100% extension
- Heavy-duty construction
- Easy to install
- Galvanized steel shelf with 1 1/2"H edge at the back
- Total height: 5"
- Can be used as a work surface

PRODUCT NO.	W x D	PRODUCT NO.	W x D
RF44-1821	18" x 21"	RF44-4824	48" x 24"
RF44-1827	18" x 27"	RF44-4827	48" x 27"
RF44-2421	24" x 21"	RF44-5424	54" x 24"
RF44-2427	24" x 27"	RF44-5427	54" x 27"
RF44-3021	30" x 21"	RF44-6024	60" x 24"
RF44-3027	30" x 27"	RF44-6027	60" x 27"
RF44-3618	36" x 18"		
RF44-3624	36" x 24"		
RF44-3627	36" x 27"		

INTEGRATED LOCK-IN MECHANISM

A



- Automatically activated when lifting the handle up
- The drawer or roll-out shelf can be opened with one hand only
- Closes with a simple push
- Stops drawer or roll-out shelf from opening on their own
- Easy to retrofit
- To order: Add "A" to the product number for the drawer, preconfigured compartment layout or roll-out shelf, e.g., RF31-362406A
- For replacement parts or to retrofit this mechanism, order an RY08-WWA

PRODUCT NO.
A

ECONO LOCK-IN MECHANISM

B



- Activated with the right hand by sliding the mechanism with thumb
- The drawer or roll-out shelf closes without having to reactivate the slide mechanism
- Stops drawer or roll-out shelf from opening on their own
- Easy to retrofit
- To order: Add B to the product number for the drawer, preconfigured compartment layout or roll-out shelf, e.g., RF31-362406B
- For replacement parts or to retrofit this mechanism, order an RY01-B

PRODUCT NO.
B

DRAWER LOCK

L3



- Compatible with all drawer dimensions
- Does not reduce the drawer's storage space
- Easy to retrofit
- To order: Add L3 to the product number for the drawer or preconfigured compartment layout, e.g., RF31-362406L3
- For replacement parts or to retrofit this mechanism, order an RY01-L3

PRODUCT NO.
L3



LOCK-OUT MECHANISM

RF85



- For both drawers and roll-out shelves
- Locks drawers and roll-out shelves in an open position
- Activated manually, only when required
- Compatible with all drawer accessories
- Plastic bins in the back row may make it more difficult to activate the mechanism

PRODUCT NO.
RF85

ADJUSTABLE SHELF

RB20 / RB21



- For storage of bulky items
- The back and side edges prevent objects from falling to the bottom of the cabinet
- Height can be adjusted in 1" increments c/c
- Up to 400lb. load capacity, evenly distributed
- Includes perforations on the top spaced 3" apart c/c for inserting SH52 Partial Dividers. Allow 3" vertical clearance for installation, see page 13

PRODUCT NO.	HOUSING SIZE W x D	LOAD CAPACITY (LB.)
RB20-1821	18" x 21"	200
RB20-1827	18" x 27"	200
RB20-2421	24" x 21"	200
RB20-2427	24" x 27"	200
RB21-3021	30" x 21"	400
RB21-3027	30" x 27"	400
RB21-3618	36" x 18"	400
RB21-3624	36" x 24"	400
RB21-3627	36" x 27"	400
RB21-4821	48" x 21"	400
RB21-4824	48" x 24"	400
RB21-4827	48" x 27"	400
RB21-5424	54" x 24"	400
RB21-5427	54" x 27"	400
RB21-6024	60" x 24"	400
RB21-6027	60" x 27"	400

NOTE: Actual usable space is 2" c/c less than the height, 2 1/8" c/c less than the width and 4" c/c less than the depth.

BOTTOM SHELF

RB23 / RB25



- For storage of bulky items
- The back and side edges prevent objects from falling to the bottom of the cabinet
- Up to 400lb. load capacity, evenly distributed
- Includes perforations on the top spaced 3" apart c/c for inserting SH52 Partial Dividers. Allow 3" vertical clearance for installation, see page 13

PRODUCT NO.	HOUSING SIZE W x D	LOAD CAPACITY (LB.)
RB23-1821	18" x 21"	200
RB23-1827	18" x 27"	200
RB23-2421	24" x 21"	200
RB23-2427	24" x 27"	200
RB25-3021	30" x 21"	400
RB25-3027	30" x 27"	400
RB25-3618	36" x 18"	400
RB25-3624	36" x 24"	400
RB25-3627	36" x 27"	400
RB25-4821	48" x 21"	400
RB25-4824	48" x 24"	400
RB25-4827	48" x 27"	400
RB25-5424	54" x 24"	400
RB25-5427	54" x 27"	400
RB25-6024	60" x 24"	400
RB25-6027	60" x 27"	400

NOTES: Actual usable space is 2" c/c less than the height, 2 1/8" c/c less than the width and 4" c/c less than the depth.
For compatibility with double integrated doors or integrated sliding doors, order an adjustable shelf

DOORS, HANDLES AND LOCKS

SINGLE INTEGRATED DOOR, SOLID OR POLYCARBONATE



RB62 / RB61



- Integrated door: RB62
- Polycarbonate integrated door: RB61
- Single door for 18"W, 24"W, 30"W and 36"W cabinets
- RB62 integrated doors have a finished back for increased rigidity and aesthetics
- RB61 integrated polycarbonate doors have excellent impact resistance
- Integrated doors are adjustable vertically and horizontally
- Compatible with RB23/RB25 Bottom Shelf and RB21/RB20 Adjustable Shelf
- Opens 180° for full access to items stored inside
- Factory installed on RA30 cabinet housings
- Some integrated door heights can be combined with drawers mounted above or below. For the latter case, you must order an RB20/RB21 Adjustable Shelf and install it above the bank of drawers
- Three types of lock available: L3 for a standard central lock, LP for a safety hasp or L50 for an electronic lock
- To order: Specify the type of door and lock required, e.g., RB61-3034L50 for a 30"W x 34"H integrated polycarbonate door and L50 electronic lock
- For a retrofit L50 mechanism or to replace the lock on a single integrated solid or polycarbonate door with an electronic lock, order an: RY50-L50

PRODUCT NO.	W x H
RB__-1820__	18" x 20"
RB__-1824__	18" x 24"
RB__-1826__	18" x 26"
RB__-1830__	18" x 30"
RB__-1834__	18" x 34"
RB__-1840__	18" x 40"
RB__-1854__	18" x 54"
RB__-2420__	24" x 20"
RB__-2424__	24" x 24"
RB__-2426__	24" x 26"
RB__-2430__	24" x 30"
RB__-2434__	24" x 34"
RB__-2440__	24" x 40"
RB__-2454__	24" x 54"

PRODUCT NO.	W x H
RB__-3020__	30" x 20"
RB__-3024__	30" x 24"
RB__-3026__	30" x 26"
RB__-3030__	30" x 30"
RB__-3034__	30" x 34"
RB__-3040__	30" x 40"
RB__-3054__	30" x 54"
RB__-3620__	36" x 20"
RB__-3624__	36" x 24"
RB__-3626__	36" x 26"
RB__-3630__	36" x 30"
RB__-3634__	36" x 34"
RB__-3640__	36" x 40"
RB__-3654__	36" x 54"



R5XEE-1004

NOTE: Not compatible with RF31 / RF35 drawers or RF40 / RF44 roll-out shelves



COMPONENTS

DOUBLE INTEGRATED DOORS, SOLID OR POLYCARBONATE



- Integrated door: RB67
- Polycarbonate integrated door: RB66
- Double doors for 30"W, 36"W, 48"W, 54"W and 60"W cabinets
- RB67 integrated doors have a finished back for increased rigidity and aesthetics
- RB66 double integrated polycarbonate doors have excellent impact resistance
- Integrated doors are adjustable vertically and horizontally
- Compatible with RB21 Adjustable Shelf
- Opens 180° for full access to items stored inside
- Factory installed on RA30 cabinet housings
- Some integrated door heights can be combined with drawers mounted above or below. You must order an RB20 / RB21 Adjustable Shelf and install it above the bank of drawers for drawers mounted below, or an RB65 crossbar for drawers mounted above



- Three types of lock available: L3 for a standard central lock, LP for a safety hasp or L50 for an electronic lock
- To order: Specify the type of door and lock required, e.g., RB66-4820L3 for 48"W x 20"H double integrated polycarbonate doors and a standard central lock
- For a retrofit L50 mechanism or to replace the lock on double integrated doors, solid or polycarbonate, with an electronic lock, order an: RY51-L50

PRODUCT NO.	W x H
RB_-3020__	30" x 20"
RB_-3024__	30" x 24"
RB_-3026__	30" x 26"
RB_-3030__	30" x 30"
RB_-3034__	30" x 34"
RB_-3040__	30" x 40"
RB_-3054__	30" x 54"
RB_-3620__	36" x 20"
RB_-3624__	36" x 24"
RB_-3626__	36" x 26"
RB_-3630__	36" x 30"
RB_-3634__	36" x 34"
RB_-3640__	36" x 40"
RB_-3654__	36" x 54"
RB_-4820__	48" x 20"
RB_-4824__	48" x 24"
RB_-4826__	48" x 26"
RB_-4830__	48" x 30"

PRODUCT NO.	W x H
RB_-4834__	48" x 34"
RB_-4840__	48" x 40"
RB_-4854__	48" x 54"
RB_-5420__	54" x 20"
RB_-5424__	54" x 24"
RB_-5426__	54" x 26"
RB_-5430__	54" x 30"
RB_-5434__	54" x 34"
RB_-5440__	54" x 40"
RB_-5454__	54" x 54"
RB_-6020__	60" x 20"
RB_-6024__	60" x 24"
RB_-6026__	60" x 26"
RB_-6030__	60" x 30"
RB_-6034__	60" x 34"
RB_-6040__	60" x 40"
RB_-6054__	60" x 54"

NOTES: Not compatible with RF31 / RF35 drawers or RF40 / RF44 roll-out shelves.
Not compatible with RB25 Bottom Shelf.

DOUBLE DOORS WITH FRAME, SOLID OR POLYCARBONATE



- Double doors with frame: RB75
- Double polycarbonate doors with frame: RB76
- Double doors for 30"W, 36"W, 48"W, 54"W and 60"W cabinets
- RB76 double polycarbonate doors with frame have excellent impact resistance
- Installs on cabinets with drawers or roll-out shelves
- Opens 180° for full access to items stored inside
- Factory installed on RA30 cabinet housings
- Thickness of the frame: 3"
- Three types of lock available: L3 for a standard central lock, LP for a safety hasp or L50 for an electronic lock
- To order: Specify the type of door and lock required, e.g., RB76-4824LP for 48"W x 24"H double polycarbonate doors with frame and a safety hasp



- For a retrofit L50 mechanism or to replace the lock on double doors with frame, solid or polycarbonate, with an electronic lock, order an: RY52-L50

PRODUCT NO.	W x H
RB_-3024__	30" x 24"
RB_-3028__	30" x 28"
RB_-3030__	30" x 30"
RB_-3034__	30" x 34"
RB_-3038__	30" x 38"
RB_-3044__	30" x 44"
RB_-3058__	30" x 58"
RB_-3624__	36" x 24"
RB_-3628__	36" x 28"
RB_-3630__	36" x 30"
RB_-3634__	36" x 34"
RB_-3638__	36" x 38"
RB_-3644__	36" x 44"
RB_-3658__	36" x 58"
RB_-4824__	48" x 24"
RB_-4828__	48" x 28"
RB_-4830__	48" x 30"
RB_-4834__	48" x 34"

PRODUCT NO.	W x H
RB_-4838__	48" x 38"
RB_-4844__	48" x 44"
RB_-4858__	48" x 58"
RB_-5424__	54" x 24"
RB_-5428__	54" x 28"
RB_-5430__	54" x 30"
RB_-5434__	54" x 34"
RB_-5438__	54" x 38"
RB_-5444__	54" x 44"
RB_-5458__	54" x 58"
RB_-6024__	60" x 24"
RB_-6028__	60" x 28"
RB_-6030__	60" x 30"
RB_-6034__	60" x 34"
RB_-6038__	60" x 38"
RB_-6044__	60" x 44"
RB_-6058__	60" x 58"

CROSSBAR FOR DOUBLE INTEGRATED DOORS

RB65



- Required for double integrated doors with drawers above
- Required a crossbar for double integrated doors with an electronic lock and drawers above, complete the following product code: RB65-WWL50

PRODUCT NO.	WIDTH
RB65-30__	30"
RB65-36__	36"
RB65-48__	48"
RB65-54__	54"
RB65-60__	60"

INTEGRATED SLIDING DOORS, SOLID OR POLYCARBONATE

RB50 / RB51



- Integrated sliding doors: RB50
- Integrated sliding polycarbonate doors: RB51
- Doors for 48"W, 54"W and 60"W single cabinets
- RB51 integrated polycarbonate doors have excellent impact resistance
- Compatible with RB21 Adjustable Shelf
- Provides maximum clearance for handling items stored in the cabinet
- Factory installed on RA30 cabinet housings
- Standard lock included
- To order: Specify the type of door required, e.g., RB51-6020L3 for a 60"W x 20"H integrated sliding polycarbonate door

PRODUCT NO.	W x H
RB__-4820L3	48" x 20"
RB__-4824L3	48" x 24"
RB__-4826L3	48" x 26"
RB__-4830L3	48" x 30"
RB__-4834L3	48" x 34"
RB__-4840L3	48" x 40"
RB__-4854L3	48" x 54"
RB__-5420L3	54" x 20"
RB__-5424L3	54" x 24"
RB__-5426L3	54" x 26"
RB__-5430L3	54" x 30"
RB__-5434L3	54" x 34"
RB__-5440L3	54" x 40"
RB__-5454L3	54" x 54"
RB__-6020L3	60" x 20"
RB__-6024L3	60" x 24"
RB__-6026L3	60" x 26"
RB__-6030L3	60" x 30"
RB__-6034L3	60" x 34"
RB__-6040L3	60" x 40"
RB__-6054L3	60" x 54"

NOTES: Not compatible with RF31 / RF35 drawers or RF40/RF44 roll-out shelves
 Not compatible with RB25 Bottom Shelf
 Not compatible with L50 Electronic Door Lock.

SLIDING DOORS WITH FRAME, SOLID OR POLYCARBONATE

RB55 / RB56

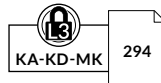

- Sliding doors with frame: RB55
- Sliding polycarbonate doors with frame RB56
- Sliding doors for double cabinets (2 x 24"W or 2 x 30"W)
- Compatible with double cabinets (2 x 24"W or 2 x 30"W) with drawers or roll-out shelves
- RB56 integrated polycarbonate doors have excellent impact resistance
- Provides maximum clearance for handling items stored in the cabinet
- Factory installed on RA30 cabinet housings
- Standard lock included
- Thickness of the frame: 3"
- To order: Specify the type of door required, e.g., RB56-6024L3 for a 60"W x 24"H sliding polycarbonate door with frame

PRODUCT NO.	W x H
RB__-4824L3	48" x 24"
RB__-4828L3	48" x 28"
RB__-4830L3	48" x 30"
RB__-4834L3	48" x 34"
RB__-4838L3	48" x 38"
RB__-4844L3	48" x 44"
RB__-4858L3	48" x 58"
RB__-6024L3	60" x 24"
RB__-6028L3	60" x 28"
RB__-6030L3	60" x 30"
RB__-6034L3	60" x 34"
RB__-6038L3	60" x 38"
RB__-6044L3	60" x 44"
RB__-6058L3	60" x 58"

NOTES: Not compatible with 48"W, 54"W or 60"W single cabinets.
 Not compatible with L50 Electronic Door Lock.

ROTATING HANDLE

Door opens by turning handle to the left or the right.



LOCK POSITION

The hasp or lock are positioned so they do not impede the hand.



DOUBLE LOCK

Add a second lock to your door.



ELECTRONIC LOCK

Easier management of cabinet access permissions.



- Two L3 / LP locks can be used for maximum security
- To order: Specify the type of lock required, e.g., RB61-3034L3+CZ06-LP to add an LP lock as well as the lock ordered

PRODUCT NO.	DESCRIPTION
CZ05-L3	To add an L3 lock
CZ06-LP	To add an LP lock

NOTE: To add a second lock to an existing door, please contact Customer Service.

PRECONFIGURED MODELS - R MULTI-DRAWER STATIONARY CABINETS

HERE ARE SOME OF OUR MOST POPULAR PRECONFIGURED MODELS OF STATIONARY MULTI-DRAWER CABINETS

- Preconfigured models for R Multi-Drawer Stationary Cabinets include a 2" front access forklift base (kick plate included)
- R Multi-Drawer Stationary Cabinets include stabilizing bars to provide extra rigidity to the housing
- To add a stainless steel, painted steel, steel with rubber mat, wood or marine edge stainless steel top, [see page 12](#)
- All cabinets include a standard cabinet lock (L3)
- For a safety hasp (LP), [see page 11](#), contact Customer Service
- For an electronic lock (L50), [see page 75](#), contact Customer Service
- Please contact your Customer Service representative for a more personalized configuration



NOTE: For interior drawer dimensions, [see pages 226-228](#).

IMPORTANT

Drawer compartments are included in all models. See the number of compartments and suggested layouts below.

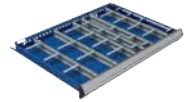

To order drawers without compartments, replace the last two digits of the model number with the next even number up.

Ex.: R5KHE-3005 with R5KHE-3006 without



NUMBER OF COMPARTMENTS (LAYOUT CODE)

DRAWER DIMENSIONS	3"H TO 5"H	6"H TO 8"H	9"H AND HIGHER
18"W x 24"D	6 (0104)	4 (0102)	2 (0100)
18"W x 27"D	6 (0104)	4 (0102)	2 (0100)
24"W x 24"D	12 (0308)	9 (0206)	6 (0104)
24"W x 27"D	20 (0316)	12 (0209)	6 (0104)
30"W x 24"D	30 (0524)	12 (0308)	9 (0206)
30"W x 27"D	25 (0420)	12 (0308)	9 (0206)
36"W x 24"D	30 (0524)	12 (0308)	9 (0206)
36"W x 27"D	30 (0425)	12 (0308)	6 (0203)
48"W x 24"D	40 (0732)	18 (0512)	8 (0304)
48"W x 27"D	32 (0724)	15 (0410)	8 (0304)
54"W x 24"D	40 (0930)	18 (0512)	10 (0405)
54"W x 27"D	40 (0930)	18 (0512)	10 (0405)
60"W x 24"D	70 (1356)	24 (0716)	12 (0308)
60"W x 27"D	84 (1370)	21 (0614)	12 (0308)

48" WIDE (W x D x H)

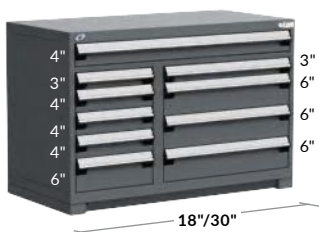

10 DRAWERS
R5KHE-3021 48" x 24" x 32"
R5KHG-3021 48" x 27" x 32"



7 DRAWERS
R5KHE-3015 48" x 24" x 32"
R5KHG-3015 48" x 27" x 32"



10 DRAWERS
R5KHE-3403 48" x 24" x 36"
R5KHG-3403 48" x 27" x 36"



11 DRAWERS
R5KHE-3405 48" x 24" x 36"
R5KHG-3405 48" x 27" x 36"



12 DRAWERS
R5KHE-3821 48" x 24" x 40"
R5KHG-3821 48" x 27" x 40"



13 DRAWERS
R5KHE-3811 48" x 24" x 40"
R5KHG-3811 48" x 27" x 40"



12 DRAWERS
R5KHE-3817 48" x 24" x 40"
R5KHG-3817 48" x 27" x 40"



11 DRAWERS
R5KHE-4409 48" x 24" x 46"
R5KHG-4409 48" x 27" x 46"

PRECONFIGURED MODELS - R MULTI-DRAWER STATIONARY CABINETS



9 DRAWERS
 R5KHE-4415 48" x 24" x 46"
 R5KHG-4415 48" x 27" x 46"



13 DRAWERS
 R5KHE-4413 48" x 24" x 46"
 R5KHG-4413 48" x 27" x 46"



17 DRAWERS
 R5KHE-5801 48" x 24" x 60"
 R5KHG-5801 48" x 27" x 60"



11 DRAWERS
 R5KHE-5809 48" x 24" x 60"
 R5KHG-5809 48" x 27" x 60"

54" WIDE (W x D x H)



8 DRAWERS
 R5KJE-3001 54" x 24" x 32"
 R5KJG-3001 54" x 27" x 32"



6 DRAWERS
 R5KJE-3003 54" x 24" x 32"
 R5KJG-3003 54" x 27" x 32"



10 DRAWERS
 R5KJE-3401 54" x 24" x 36"
 R5KJG-3401 54" x 27" x 36"



9 DRAWERS
 R5KJE-3403 54" x 24" x 36"
 R5KJG-3403 54" x 27" x 36"



8 DRAWERS
 R5KJE-3405 54" x 24" x 36"
 R5KJG-3405 54" x 27" x 36"



9 DRAWERS
 R5KJE-3801 54" x 24" x 40"
 R5KJG-3801 54" x 27" x 40"



9 DRAWERS
 R5KJE-3803 54" x 24" x 40"
 R5KJG-3803 54" x 27" x 40"



11 DRAWERS
 R5KJE-4401 54" x 24" x 46"
 R5KJG-4401 54" x 27" x 46"



12 DRAWERS
 R5KJE-5801 54" x 24" x 60"
 R5KJG-5801 54" x 27" x 60"

PRECONFIGURED MODELS - R MULTI-DRAWER STATIONARY CABINETS

60" WIDE (W x D x H)



8 DRAWERS
R5KKE-3007 60" x 24" x 32"
R5KKG-3007 60" x 27" x 32"



10 DRAWERS
R5KKE-3403 60" x 24" x 36"
R5KKG-3403 60" x 27" x 36"



11 DRAWERS
R5KKE-3405 60" x 24" x 36"
R5KKG-3405 60" x 27" x 36"



12 DRAWERS
R5KKE-3809 60" x 24" x 40"
R5KKG-3809 60" x 27" x 40"



10 DRAWERS
R5KKE-3813 60" x 24" x 40"
R5KKG-3813 60" x 27" x 40"



11 DRAWERS
R5KKE-4405 60" x 24" x 46"
R5KKG-4405 60" x 27" x 46"



10 DRAWERS
R5KKE-4407 60" x 24" x 46"
R5KKG-4407 60" x 27" x 46"



18 DRAWERS
R5KKE-5813 60" x 24" x 60"
R5KKG-5813 60" x 27" x 60"



12 DRAWERS
R5KKE-5819 60" x 24" x 60"
R5KKG-5819 60" x 27" x 60"

ACCESSORIES

For More Information: 866-333-0728

SIDE PANELS

SIDE UTILITY PANEL

RC02

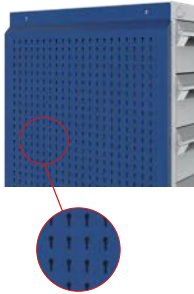

- 5S storage accessory
- Maximizes the cabinet's storage space
- Installs on the sides of R cabinets
- Quick and easy installation
- Includes perforations spaced 1" apart c/c for hanging a range of hooks
- Load capacity: 50lb./sq. ft., 500lb. max. per panel
- Compatible with WM9F, WM9G, WM9H, WM9J and WM9L light-duty hooks, and WM9A and WM9B heavy-duty hooks
- Compatible with WMQ9 tool holders, WM9C bin rails, WM9D can holders, WM9M and WM9N hooks, WM9P spool and roll holders, and WM21 shelves
- Available in all standard R cabinet dimensions (depth, height)
- To order: Specify the housing height required, e.g., RC02-2434 for a 24"D x 34"H housing

PRODUCT NO.	CABINET DEPTH	NO. OF HOLES
RC02-18 __	18"	15
RC02-21 __	21"	18
RC02-24 __	24"	21
RC02-27 __	27"	24

NOTE: Full height installation only.

SIDE PANEL FOR PLASTIC BINS

RC04

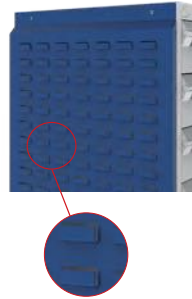

- 5S storage accessory
- Maximizes the cabinet's storage space
- Installs on the sides of R cabinets
- Quick and easy installation
- Holds RG20 plastic bins
- Compatible with all commercially available brands of plastic bins with a hanging lip
- Available in all standard R cabinet dimensions (depth, height)
- To order: Specify the housing height required: RC04-2434 for a 24"D x 34"H housing

PRODUCT NO.	CABINET DEPTH
RC04-18 __	18"
RC04-21 __	21"
RC04-24 __	24"
RC04-27 __	27"

NOTE: Full height installation only.



SECURITY MECHANISMS

ELECTRONIC LOCK FOR CABINET WITH DRAWERS L50



- Electronically locks all drawers in the cabinet at the same time
- No key required
- Up to 20 different users can be programmed
- 4 to 8 digit access codes
- Simplifies access management to drawers
- To order the complete mechanism with a cabinet with drawers, order an RB01-WWDDHHL50
- To order as a replacement lock, order an HA48-L50
- One electronic lock system per cabinet.

PRODUCT NO.
L50

ELECTRONIC LOCK FOR DOORS L50



- Electronically locks a cabinet door
- No key required
- Up to 20 different users can be programmed
- 4-8 digit access codes
- Compatible with single, double and polycarbonate swing doors, with or without frame (RB61, RB62, RB66, RB67, RB75 and RB76)
- To order: Add L50 to the door product code, e.g. RB61-3620L50

PRODUCT NO.
L50

R CABINET BUMPERS RB9J



- Protects R cabinets from bumps and damage
- Protection kit for all four corners of cabinets
- Vertical bumpers and endcaps made from resistant soft PVC
- Quick and easy installation with double-sided adhesive tape
- Tool-free installation
- To order: Specify the housing height required, e.g., RB9J-30 02 for installation on a 30"H R cabinet and an RD01 side housing

PRODUCT NO.	COMPATIBLE WITH
RB9J- _ 01	RA35 cabinet
RB9J- _ 02	RA35 cabinet and RD01 side housing
RB9J- _ 03	RA35 cabinet and 1 RC02 / RC04 side panel
RB9J- _ 04	RA35 cabinet and 2 RC02 / RC04 side panels

NOTES: Not compatible with RB10 vertical security bars.
Not compatible with RC00 foldaway shelves.
Not compatible with RB75 and RB76 doors with frame.

VERTICAL SECURITY BAR RB10



- Two vertical bars are required on a multi-drawer cabinet, one on the right-hand side of the cabinet and one on the left
- Covers a bank of drawers from 18" to 54" high
- Allows full access to drawers even when installed against a wall
- Order two vertical security bars corresponding to the internal height of the cabinet, e.g., 54" bars for a 58"H cabinet
- To order, add A to the product number for the right bar and B for the left bar

PRODUCT NO.	HEIGHT
RB10-18LP_	18"
RB10-20LP_	20"
RB10-24LP_	24"
RB10-26LP_	26"
RB10-30LP_	30"
RB10-34LP_	34"
RB10-36LP_	36"
RB10-40LP_	40"
RB10-54LP_	54"

NOTE: The vertical security bar cannot be installed on the central partition.

R2V VERTICAL STORAGE

R2V VERTICAL STORAGE



INDEX	PAGE(S)
R2V Vertical Storage	76-79
Preconfigured Models	79-82
Accessories	83
Components	84-85

R2V VERTICAL STORAGE

The R2V Vertical Storage System is the only product of its type on the market. Stacked above an R cabinet (sold separately), it is ideal for storing more items and equipment while keeping them within easy reach. By using all vertical space available, you can free up floor space and stay perfectly organized.

The drawers – which are fitted with a lock-in mechanism – open to full extension and boast a 200lb. load capacity. They provide high-density and tidy storage, which helps boost your productivity and efficiency.



LIFETIME WARRANTY

The Rousseau drawer rolling mechanism is covered by a lifetime warranty.



RL-5HDG34004N

THE ROUSSEAU DIFFERENCE

DRAWER INTERIOR

Pale-gray color for better visibility

ORGANIZATION

Front and back inner panels with perforations for hanging tools. Optional utility panels and a range of 55 accessories also available

LOCKS

Standard lock included on all models. Optional electronic lock and two-user lock also available



ONE-DRAWER-AT-A-TIME SYSTEM

Available as an option

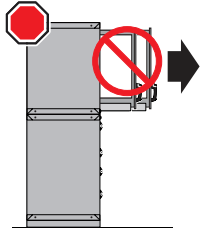

SECURE

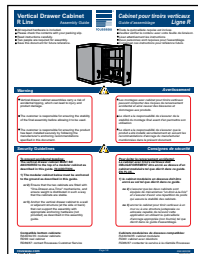

LOAD CAPACITY

200lb. load capacity per drawer



MAGNETIC DIVIDER

Easy to reposition. Front-to-back and left-to-right dividers available

ADJUSTABLE TRAY

Ideal for storing different tools and products. Easy tool-free repositioning in one inch increments



PVC DRAWER LINER



PLASTIC BINS



HEAVY-DUTY, COMFORTABLE AND ERGONOMIC HANDLE



GENERAL DIMENSIONS



VERTICAL DRAWER DIMENSIONS

24"D DRAWERS

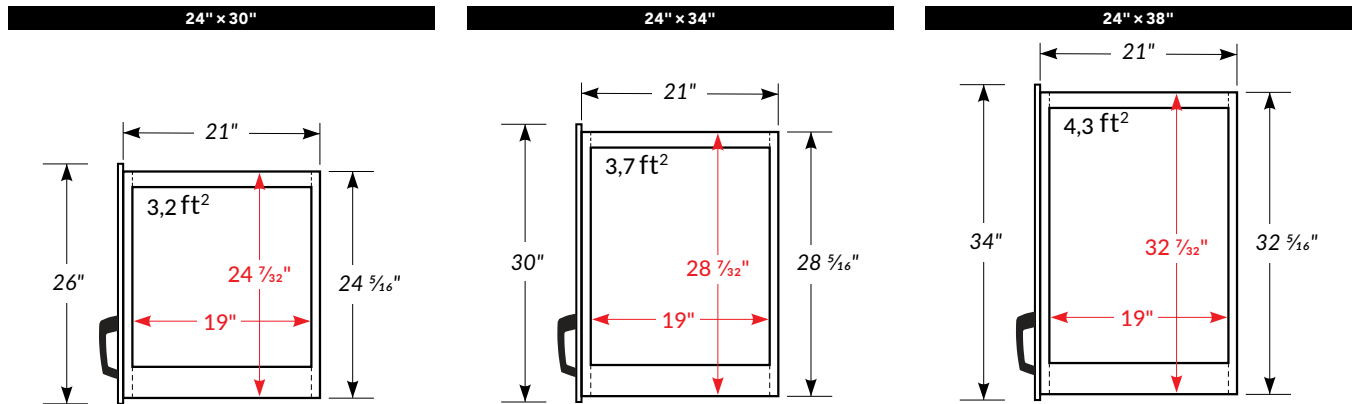

27"D DRAWERS

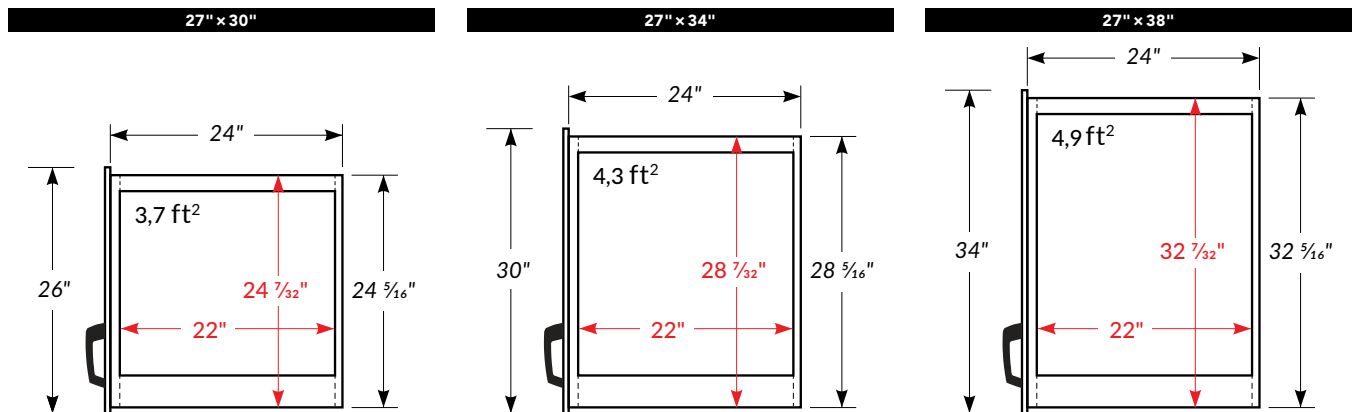

DRAWER WIDTHS

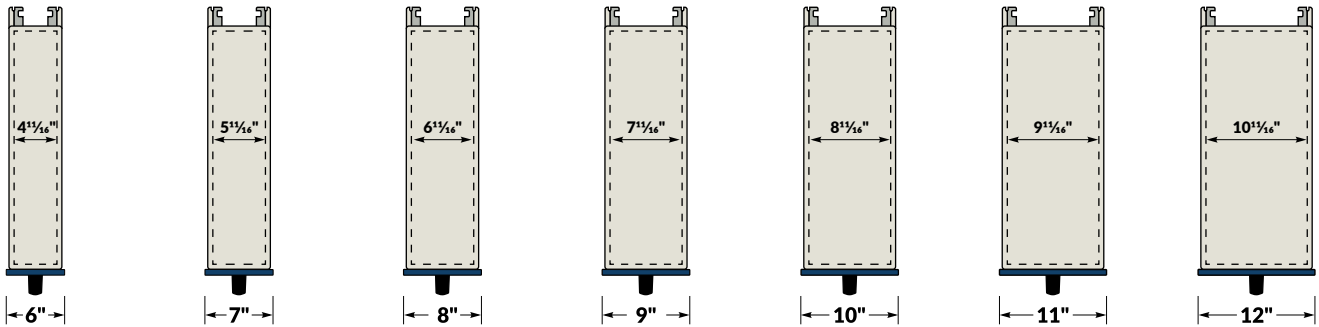

SOME OF OUR MOST POPULAR R2V CABINET MODELS ARE SHOWN BELOW:

- To subdivide your drawers see [page 82](#) for accessory layouts, or see [page 83](#) for available accessories.
- All preconfigured cabinet models include a standard lock on the cabinet and an integrated lock-in mechanism on the drawers.

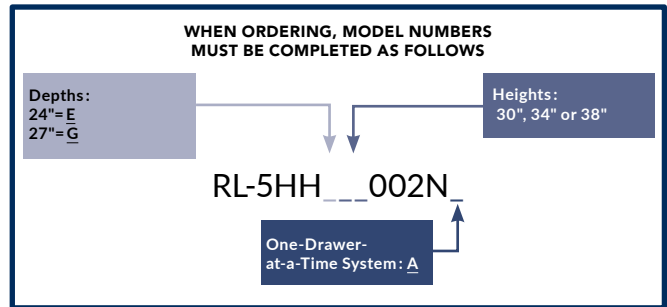

The R2V Vertical Storage System must be installed on top of an R cabinet of the same width. It cannot be installed directly on the ground. Anchoring the R2V cabinet ensures the unit is stable. For more information, refer to assembly guide R4E. There is no mobile version of this product available.

24" WIDE



3 DRAWERS
RL-5HC__002N_



3 DRAWERS
RL-5HC__004N_



2 DRAWERS
RL-5HC__006N_

PRECONFIGURED MODELS

30" WIDE



3 DRAWERS
RL-5HD___002N_



4 DRAWERS
RL-5HD___004N_



3 DRAWERS
RL-5HD___006N_

36" WIDE



4 DRAWERS
RL-5HE___002N_



4 DRAWERS
RL-5HE___004N_



3 DRAWERS
RL-5HE___006N_

48" WIDE



6 DRAWERS
RL-5HH___002N_



6 DRAWERS
RL-5HH___004N_



4 DRAWERS
RL-5HH___006N_

54" WIDE



5 DRAWERS
RL-5HJ__002N_



6 DRAWERS
RL-5HJ__004N_



5 DRAWERS
RL-5HJ__006N_



5 DRAWERS
RL-5HJ__008N_

60" WIDE



8 DRAWERS
RL-5HK__002N_



6 DRAWERS
RL-5HK__004N_



5 DRAWERS
RL-5HK__006N_



6 DRAWERS
RL-5HK__008N_

PRECONFIGURED MODELS

VERTICAL DRAWER INTERIORS

Choose the interior layout of each drawer using the preconfigured suggestions on this page. Complete your layouts with accessories, [see page 83](#), or in the 5S and Wall Mounted Storage section, [see pages 214-215](#), as needed.

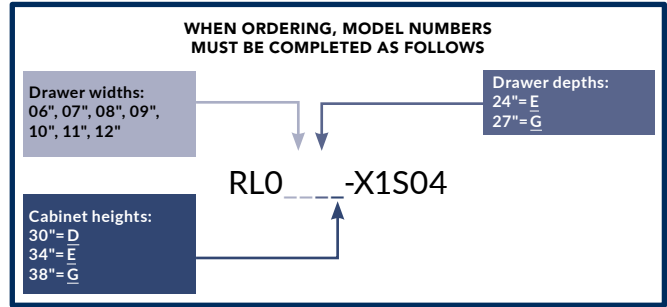

TRAY WITH 8 MAGNETIC DIVIDERS
RLO___-T1001



ADJUSTABLE UTILITY PANEL¹ AND 20 HOOKS
RLO___-U0C02



SIDE UTILITY PANEL, 20 HOOKS AND PLASTIC BINS²
RLO___-U0S03



2 TRAYS AND 12 MAGNETIC DIVIDERS
RLO___-T2001



ADJUSTABLE UTILITY PANEL¹,
2 TRAYS AND 16 MAGNETIC DIVIDERS³
RLO___-X2C01



SIDE UTILITY PANEL, 1 TRAY,
4 MAGNETIC DIVIDERS AND PLASTIC BINS²
RLO___-X1S04

NOTES: 1: Hook perforations on both sides of the panel. Panel position is adjustable across the shelf width.
2: Not available for 7"W drawers.
3: Available for 10"W drawers and over.
4: Panel position is adjustable across the shelf width.

SIDE UTILITY PANEL

RL40



- For locating tools quickly and easily
- Full-height and full-depth panel
- Installs on the far right of the drawer but can be easily repositioned on the left
- Color: Light Gray 071
- Depths available: 24" (18 holes) and 27" (21 holes)
- To order: Specify the depth required

PRODUCT NO.	CABINET HEIGHT
RL40-__30	30"
RL40-__34	34"
RL40-__38	38"

ADJUSTABLE UTILITY PANEL

RL43



- For locating tools quickly and easily
- Full-height and full-depth panel
- Tools can be hung on each side of the panel without obstructing the drawer
- Width adjustable in 1/2" increments c/c
- Color: Light Gray 071
- Depths available: 24" (18 holes) and 27" (21 holes)
- To order: Specify the depth required

PRODUCT NO.	CABINET HEIGHT
RL43-__30	30"
RL43-__34	34"
RL43-__38	38"

ADJUSTABLE TRAY

RL21



- Ideal for storing assorted products and tools (cans, bottles, etc.)
- Tool-free installation and adjustment
- Includes edges to prevent objects from falling to the bottom of the drawer
- Height adjustable in 1" increments c/c
- Compatible with side utility panels. For compatibility with adjustable utility panels, refer to technical guide R68
- Color: Light Gray 071
- Widths available: 05", 06", 07", 08", 09", 10", 11" and 12"
- To order: Specify the width required

PRODUCT NO.	DEPTH
RL21-__24	24"
RL21-__27	27"

MAGNETIC DIVIDER

RL60 / RL61



Front to back

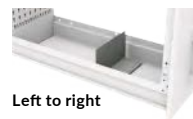

Left to right

- Installs on drawer bottoms and adjustable trays
- Includes a magnetic strip for easy repositioning
- Divider height: 4"
- Color: Light Gray 071

PRODUCT NO.	
RL60-2404	24" front to back
RL60-2704	27" front to back
RL61-__04	Left to right

NOTES: Complete the RL61 number with the drawer or the tray width: 05", 06", 07", 08", 09", 10", 11" and 12".

Not compatible with non-slip drawer/tray liners.

NON-SLIP DRAWER/TRAY LINER

RL49



- Protects tools stored in the drawer or on a tray
- Thickness: 1/16"
- Widths available: 05", 06", 07", 08", 09", 10", 11" and 12"
- To order: Specify the width required

PRODUCT NO.	DEPTH
RL49-__24	24"
RL49-__27	27"

NOTE: Not compatible with magnetic dividers.

LABEL HOLDER

RL81 / RL82



- For 7/8"H paper labels
- Label holder height: 15/16"
- Widths available: 06" and 09"
- To order: Specify the width required

PRODUCT NO.	
RL81-__	Self-adhesive
RL82-__	Magnetic



Refer to technical guide R68 for details on accessories compatibility.

VERTICAL DRAWER



- Painted steel drawer
- Interior color: Light Gray 071
- Front and back inner panels with perforations for hanging tools
- 200lb. load capacity, 100% extension
- Heavy-duty construction
- Drawer widths available: 06", 07", 08", 09", 10", 11" and 12"
- Wide range of accessories available to customize the drawer to your storage needs, [see page 83](#)
- For preconfigured models of vertical drawers with accessories, [see page 82](#)
- Available with an integrated lock-in mechanism

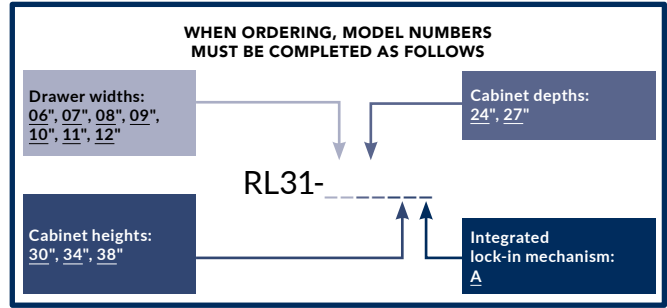

R2V VERTICAL HOUSING

RL30



- Designed to accommodate RL31 vertical drawers
- Heights available: 30", 34" and 38"
- To order: Specify the height required, e.g., RL30-482430
- For a safety hasp lock, replace L3 with LP
- For an electronic lock, replace L3 with L50
- For a One-Drawer-at-a-Time system, add A to the end of the product number

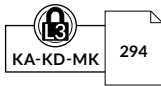

PRODUCT NO.	W × D	INTERIOR W
RL30-1824__-L3_	18" × 24"	16"
RL30-1827__-L3_	18" × 27"	16"
RL30-2424__-L3_	24" × 24"	22"
RL30-2427__-L3_	24" × 27"	22"
RL30-3024__-L3_	30" × 24"	28"
RL30-3027__-L3_	30" × 27"	28"
RL30-3624__-L3_	36" × 24"	34"
RL30-3627__-L3_	36" × 27"	34"
RL30-4824__-L3_	48" × 24"	46"
RL30-4827__-L3_	48" × 27"	46"
RL30-5424__-L3_	54" × 24"	52"
RL30-5427__-L3_	54" × 27"	52"
RL30-6024__-L3_	60" × 24"	58"
RL30-6027__-L3_	60" × 27"	58"

NOTE: For a cabinet housing for two users, [see page 292](#).



The R2V Vertical Storage System must be installed on top of an R cabinet of the same width. It cannot be installed directly on the ground.

Anchoring the R2V cabinet ensures the unit is stable. For more information, refer to assembly guide R4E.

There is no mobile version of this product available.

CENTRAL LOCKING SYSTEM

L3



- Locks all vertical drawers in the cabinet at the same time
- Drawer positions can be changed
- Easy retrofit
- To order: Add L3 to the cabinet product number, e.g., RL30-302738L3
- For replacement parts or to retrofit this mechanism, order an RL00-WWDDL3



PRODUCT NO.
L3

SAFETY HASP SYSTEM

LP

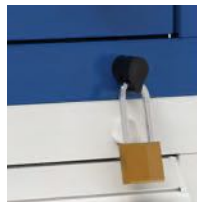

- Locks all vertical drawers in the cabinet at the same time
- Drawer positions can be changed
- To order: Add LP to the cabinet product number, e.g., RL30-302738LP
- For replacement parts or to retrofit this mechanism, order an RL00-WWDDL^{LP}

PRODUCT NO.
LP

ELECTRONIC LOCK

L50



- Locks all vertical drawers in the cabinet at the same time
- Drawer positions can be changed
- Fast and easy to use
- No key required
- Up to 20 different users
- 4- to 8-digit access codes
- To order: Add L50 to the cabinet product number, e.g., RL30-302738L50
- For replacement parts or to retrofit this mechanism, order an RL00-WWDDL^{L50}



PRODUCT NO.
L50



ONE-DRAWER-AT-A-TIME SYSTEM

A

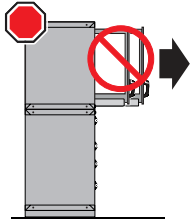

- Prevents more than one drawer from opening at the same time for greater stability
- To order: Add A to the model number, see [pages 79-81](#)

LOCK-OUT MECHANISM

RL85



- Installs on R2V vertical drawers
- Locks vertical drawers in the open position
- Activates manually only when required

PRODUCT NO.

RL85

NOTES: Not compatible with an RL40 Side Utility Panel installed on the same side
Not compatible with an RL91 Security Panel installed on the same side

SECURITY PANEL

RL91



- Divides an RL29 cabinet between two users, see [page 292](#)
- Must be ordered to block access between vertical drawers
- Color: black
- To order: Specify the housing height required – 30", 34" or 38", e.g., RL91-2430

PRODUCT NO. DEPTH

RL91-24__ 24"

RL91-27__ 27"

INTEGRATED LOCK-IN MECHANISM

A



- Stops the vertical drawer from opening on its own
- Activates by pressing the handle button
- The vertical drawer can be opened with one hand only
- Closes with a simple push
- To order: Add A to the drawer product number, e.g., RL31-062430A
- For replacement parts or to retrofit this mechanism, order an RY48-A

PRODUCT NO.

A

HORIZONTAL SECURITY BAR

RL10



- Locks all vertical drawers in a cabinet with a key or padlock
- Spans the width of the cabinet
- Allows full access to drawers
- To order: Add L3 or LP to the product number, e.g., RL10-48L3



PRODUCT NO.

WIDTH

RL10-18__ 18"

RL10-24__ 24"

RL10-30__ 30"

RL10-36__ 36"

RL10-48__ 48"

RL10-54__ 54"

RL10-60__ 60"

NOTE: Compatible with an R cabinet underneath with an RB10 Vertical Security Bar installed

