

Shown here are several of the most popular mobile modular cabinet models.

The 24" W cabinet models include 4" casters; 2 swivels with total-lock brake system and 2 rigid. Proposals include an econo lock-in mechanism (B);

The 30", 36", 48" (2 x 24") and 60" (2 x 30") wide cabinet models include 6" casters; 2 swivel with total-lock brake system and 2 rigid. Proposals include an integrated lock-in mechanism (A);

Cabinets come with standard lock (on doors also);

To add a stainless steel, galvanized steel, painted steel, steel with rubber mat, wood or marine edge stainless steel top;

All models are factory assembled and ready to use. Doors are installed with hinges on the right side. However, they can be installed on the left upon request.

SEE PAGE 43

SEE PAGE 40

IMPORTANT

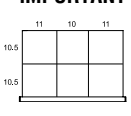

Drawer partitions are included in models.

NOTE

For drawers without partitioning, complete the even number following the last two digits of the model.
Ex.: R5BCD-2801 with R5BCD-2802 without



To prevent the mobile cabinet from tipping, distribute the load evenly.



SEE PAGE 198
KA, KD or MK

Number of Compartments (layout code)										
Drawer dimensions	24" x 21"	24" x 27"	30" x 21"	30" x 27"	36" x 18"	36" x 24"	48" x 24"	48" x 27"	60" x 24"	60" x 27"
3" to 5"	12 (0308)	20 (0316)	24 (0518)	25 (0420)	24 (0518)	30 (0524)	40 (0732)	32 (0724)	70 (1356)	84 (1370)
6" to 8"	9 (0206)	12 (0209)	12 (0308)	12 (0308)	8 (0304)	12 (0308)	15 (0410)	15 (0410)	24 (0716)	21 (0614)
9" and higher	4 (0102)	6 (0104)	6 (0203)	9 (0206)	6 (0203)	9 (0206)	8 (0304)	8 (0304)	12 (0308)	12 (0308)

NOTE For inside drawer dimensions.

SEE PAGES 144-145

24" Wide

Each model includes two front handles.



4 drawers
R5BCD-2801 24" x 21" x 33 1/4"
R5BCG-2801 24" x 27" x 33 1/4"



4 drawers
R5BCD-2803 24" x 21" x 33 1/4"
R5BCG-2803 24" x 27" x 33 1/4"



3 drawers
R5BCD-2805 24" x 21" x 33 1/4"
R5BCG-2805 24" x 27" x 33 1/4"



6 drawers
R5BCD-3051 24" x 21" x 35 1/4"
R5BCG-3051 24" x 27" x 35 1/4"



5 drawers
R5BCD-3053 24" x 21" x 35 1/4"
R5BCG-3053 24" x 27" x 35 1/4"



5 drawers
R5BCD-3055 24" x 21" x 35 1/4"
R5BCG-3055 24" x 27" x 35 1/4"



5 drawers
R5BCD-3401 24" x 21" x 39 1/4"
R5BCG-3401 24" x 27" x 39 1/4"



7 drawers
R5BCD-3851 24" x 21" x 43 1/4"
R5BCG-3851 24" x 27" x 43 1/4"

30" and 36" Wide

Each model includes one side handle.



1 drawer / 1 door / 1 bottom shelf

R5BDD-2801	30" x 21" x 35 1/2"
R5BDG-2801	30" x 27" x 35 1/2"
R5BEC-2801	36" x 18" x 35 1/2"
R5BEE-2801	36" x 24" x 35 1/2"



4 drawers

R5BDD-2803	30" x 21" x 35 1/2"
R5BDG-2803	30" x 27" x 35 1/2"
R5BEC-2803	36" x 18" x 35 1/2"
R5BEE-2803	36" x 24" x 35 1/2"



6 drawers

R5BDD-3001	30" x 21" x 37 1/2"
R5BDG-3001	30" x 27" x 37 1/2"
R5BEC-3001	36" x 18" x 37 1/2"
R5BEE-3001	36" x 24" x 37 1/2"



5 drawers

R5BDD-3003	30" x 21" x 37 1/2"
R5BDG-3003	30" x 27" x 37 1/2"
R5BEC-3003	36" x 18" x 37 1/2"
R5BEE-3003	36" x 24" x 37 1/2"



5 drawers

R5BDD-3005	30" x 21" x 37 1/2"
R5BDG-3005	30" x 27" x 37 1/2"
R5BEC-3005	36" x 18" x 37 1/2"
R5BEE-3005	36" x 24" x 37 1/2"



6 drawers

R5BDD-3007	30" x 21" x 37 1/2"
R5BDG-3007	30" x 27" x 37 1/2"
R5BEC-3007	36" x 18" x 37 1/2"
R5BEE-3007	36" x 24" x 37 1/2"



4 drawers

R5BDD-3019	30" x 21" x 37 1/2"
R5BDG-3019	30" x 27" x 37 1/2"
R5BEC-3019	36" x 18" x 37 1/2"
R5BEE-3019	36" x 24" x 37 1/2"



3 drawers

R5BDD-3021	30" x 21" x 37 1/2"
R5BDG-3021	30" x 27" x 37 1/2"
R5BEC-3021	36" x 18" x 37 1/2"
R5BEE-3021	36" x 24" x 37 1/2"



1 roll-out shelf / 4 drawers

R5BDD-3015	30" x 21" x 37 1/2"
R5BDG-3015	30" x 27" x 37 1/2"
R5BEC-3015	36" x 18" x 37 1/2"
R5BEE-3015	36" x 24" x 37 1/2"



7 drawers

R5BDD-3801	30" x 21" x 45 1/2"
R5BDG-3801	30" x 27" x 45 1/2"
R5BEC-3801	36" x 18" x 45 1/2"
R5BEE-3801	36" x 24" x 45 1/2"



7 drawers

R5BDD-3803	30" x 21" x 45 1/2"
R5BDG-3803	30" x 27" x 45 1/2"
R5BEC-3803	36" x 18" x 45 1/2"
R5BEE-3803	36" x 24" x 45 1/2"



4 drawers / 1 door / 1 bottom shelf

R5BDD-3805	30" x 21" x 45 1/2"
R5BDG-3805	30" x 27" x 45 1/2"
R5BEC-3805	36" x 18" x 45 1/2"
R5BEE-3805	36" x 24" x 45 1/2"

48" and 60" Wide

Each model includes one side handle.



6 drawers

R5BHE-3001	48" x 24" x 37 1/2"
R5BHG-3001	48" x 27" x 37 1/2"
R5BKE-3001	60" x 24" x 37 1/2"
R5BKG-3001	60" x 27" x 37 1/2"



4 drawers

R5BHE-3019	48" x 24" x 37 1/2"
R5BHG-3019	48" x 27" x 37 1/2"
R5BKE-3019	60" x 24" x 37 1/2"
R5BKG-3019	60" x 27" x 37 1/2"



5 drawers

R5BHE-3009	48" x 24" x 37 1/2"
R5BHG-3009	48" x 27" x 37 1/2"
R5BKE-3009	60" x 24" x 37 1/2"
R5BKG-3009	60" x 27" x 37 1/2"



5 drawers

R5BHE-3011	48" x 24" x 37 1/2"
R5BHG-3011	48" x 27" x 37 1/2"
R5BKE-3011	60" x 24" x 37 1/2"
R5BKG-3011	60" x 27" x 37 1/2"



1 drawer / 1 double door / 1 bottom shelf

R5BHE-3013	48" x 24" x 37 1/2"
R5BHG-3013	48" x 27" x 37 1/2"
R5BKE-3013	60" x 24" x 37 1/2"
R5BKG-3013	60" x 27" x 37 1/2"



1 roll-out shelf / 4 drawers

R5BHE-3015	48" x 24" x 37 1/2"
R5BHG-3015	48" x 27" x 37 1/2"
R5BKE-3015	60" x 24" x 37 1/2"
R5BKG-3015	60" x 27" x 37 1/2"

48" and 60" Wide (2 x 24" and 2 x 30")

Each cabinet includes one side handle and one brace to attach the cabinets.



8 drawers

R5DHG-3011	48" x 27" x 37 1/2"
R5DKG-3011	60" x 27" x 37 1/2"



7 drawers

R5DHG-3013	48" x 27" x 37 1/2"
R5DKG-3013	60" x 27" x 37 1/2"



8 drawers / 1 roll-out shelf

R5DHG-3009	48" x 27" x 37 1/2"
R5DKG-3009	60" x 27" x 37 1/2"



8 drawers / 1 door / 1 adjustable shelf / 1 bottom shelf

R5DHG-3801	48" x 27" x 45 1/2"
R5DKG-3801	60" x 27" x 45 1/2"



10 drawers

R5DHG-3809	48" x 27" x 45 1/2"
R5DKG-3809	60" x 27" x 45 1/2"



10 drawers

R5DHG-3807	48" x 27" x 45 1/2"
R5DKG-3807	60" x 27" x 45 1/2"



Security Accessories and Recommendations

"R" MOBILE CABINET

Vertical Security Bar

RB10



Lock all of the cabinet drawers with one padlock; Safety hasp is located at the top of the bar to facilitate access;
Available to cover overall drawer heights from 24" to 34";
Installs on the right side.

Product #	Height
RB10-24LPA	24"
RB10-26LPA	26"
RB10-30LPA	30"
RB10-34LPA	34"

Security Panel

RF91

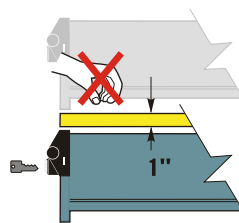

Blocks access between two drawers with locks; Usable space in cabinet reduced by 1";
Installed between two drawers;
Allows for the cabinet to be divided up for more than one user;
Order by specifying the width and dept. Ex.: RF91-36 24 for a 36" W x 24" D security panel.

Product #
RF91- _____

Cabinet Lock



Allows user to lock all drawers and roll-out shelves in the cabinet at same time;
Possible to change drawer and roll-out shelf positions;
Easy to retrofit;
Order by adding L3 to the cabinet housing number. Ex.: RA30-302758L3;
For replacement parts or to retrofit this mechanism, order RB00-XXXXL3.

Product #
L3 _____

Cabinet Safety Hasp



Allows user to lock all drawers and roll-out shelves in the cabinet at the same time;
Possible to change drawer and roll-out shelf positions;
Alternative to the RB10 vertical security bar;
Easy to retrofit;
Order by adding LP to the cabinet housing number. Ex.: RA30-302758LP;
For replacement parts or to retrofit this mechanism, order RB00-XXXXLP.

Product #
LP _____

True One-Drawer-at-a-Time System



RB15

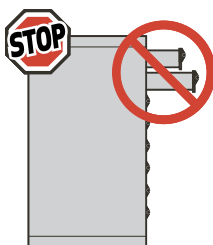

Prevents opening several drawers simultaneously. This ensures cabinet stability and protects the users;

To retrofit this mechanism, order RB15-XX-XX;

For factory installation, add A to the cabinet housing number;

One kit per cabinet.

SEE PAGE 42

Product #	Cabinet Height
RB15-28-08	28"
RB15-30-08	30"
RB15-34-10	34"
RB15-38-11	38"



Recommended for mobile cabinets and cabinets not anchored to the floor.

"R" Double Mobile Cabinet : Appropriate Combination

In order to determine the appropriate cabinet combination, ask yourself the following questions : What is the desired cabinet width and what is the desired capacity? Here are the possibilities :

Standard Double Cabinet

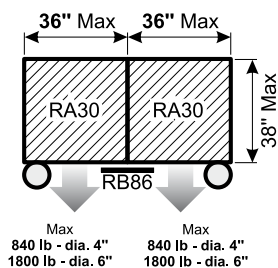

Double Cabinet

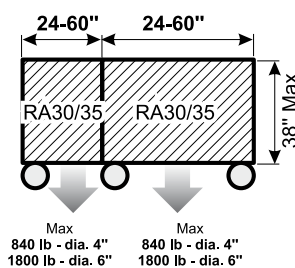

Side Cabinet

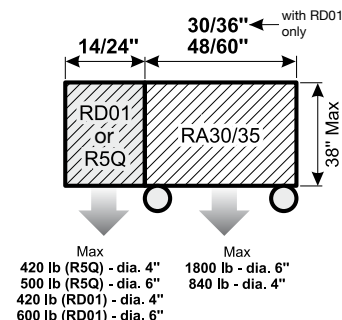

IMPORTANT With or without work surface WS08/14/16/17, RC35/36/37 (4 screws per cabinet).



The height of the cabinet should not exceed 38" in order to assure cabinet stability when it is moved.

For More Information: 866-333-0728

"R" MOBILE CABINET

Hanging Side Cabinet

Hanging Side Cabinet - Side Access

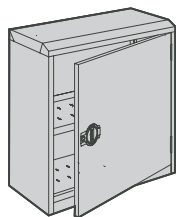

Side housing specifically designed to be installed on the side of RA30 cabinet housing;

Includes one bottom shelf;

Shelves adjustable every 1" c/c;

SH52 dividers can be installed on shelves;

Equipped with holes on the top to allow installation between one common work surface to a RA30 cabinet;

Door opens 180° for full access to items stored inside;

Door comes with standard lock;

Capacity : 600 lb;

Choice of doors. Complete the product number from the chart with the following :

01 : Solid door

02 : Polycarbonate door

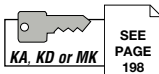

Height	Width x Depth		Number of (RD05) Adjustable Shelves
	24" x 14"	27" x 14"	
24"	R5QCA-24	R5QPA-24	-
28"	R5QCA-28	R5QPA-28	1
30"	R5QCA-30	R5QPA-30	1
34"	R5QCA-34	R5QPA-34	1
38"	R5QCA-38	R5QPA-38	2
For cabinet	24" D	27" D	



R5XHE-1001

NOTE

For compatibility with a work surface, choose the part number of a work surface 12" wider than your cabinet. Ex.: RC -4824 for a mobile 36" W x 24" D cabinet.

Hanging Side Cabinet - Front Access

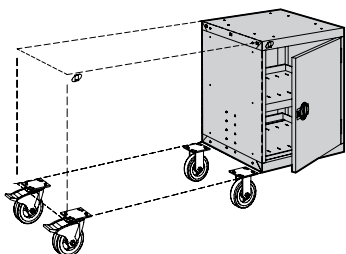

Side cabinet designed to be installed on the side of RA30 cabinet housing;

The shelves are adjustable at every 1" c/c;

SH52 dividers can be installed on both bottom and adjustable shelves;

The roll-out shelf has a capacity of 175 lb, 75% extension;

Equipped with holes on the top to allow installation between one common work surface to a RA30 cabinet;

Door opens 180°, allowing clearance space for easy handling of objects in the cabinet;

Door comes with standard lock;

Capacity : 500 lb;

Choice of configurations. Complete the number:

Bottom shelf (RB23)

and adjustable shelf(ves) (RB22) :

03 : Solid door

05 : Polycarbonate door

Roll-out shelves (RF50)

04 : Solid door

06 : Polycarbonate door

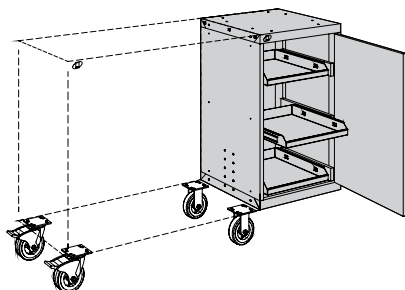

NOTE

For compatibility with a work surface, choose the part number of a work surface 24" wider than your cabinet.

Ex.: RC -7224 for a mobile 48" W x 24" D cabinet.



R5XRE-3001

Height	Width x Depth			Number of (RB22) Adjustable Shelves	Number of (RF50) Roll-Out Shelves
	24" x 18"	24" x 21"	24" x 24"		
28"	R5QCC-28	R5QCD-28	R5QCE-28	1	2
30"	R5QCC-30	R5QCD-30	R5QCE-30	1	2
34"	R5QCC-34	R5QCD-34	R5QCE-34	1	2
38"	R5QCC-38	R5QCD-38	R5QCE-38	2	3
For cabinet	18" D	21" D	24" D		

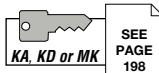

It is recommended to install this product on a 48" or wider.

Cabinet Tops

Steel Top with Rubber Mat

RC32



Non-slip rubber surface;
Sides and back formed with a double fold : 1" high.

Laminated Wood Top

WS14



Made from strips of laminated hardwood;
Front 90° rounded edge for added comfort;
Thickness : 1 3/4";
Good impact resistance;
Attractive appearance.

Stainless Steel Top

RC35



16 GA stainless steel : RC35-XXXX;
12 GA stainless steel : RC35-XXXX-12;
Serves as a work surface and protects the cabinet against impacts;
Particle board top with stainless steel cover (brushed finish #4);
Excellent corrosion and chemical resistance;
The top respects the CARB regulations on formaldehyde emissions;
Welded corners for attractive look;
Thickness : 1 3/4";
To order a top in 12 GA, complete the product number with 12.

Marine Edge Stainless Steel Top

RC35



Marine edge 16 GA stainless steel : RC35-XXXX-16M;
Marine edge 12 GA stainless steel : RC35-XXXX-12M;
Prevents small objects or liquids from falling or spilling from the worksurface;
Serves as a work surface and protects cabinet against impacts;
Composite wood top with stainless steel cover (brushed finish #4);
Excellent corrosion and chemical resistance;
The top respects the CARB regulations on formaldehyde emissions;
Welded corners for attractive look;
Thickness : 1 3/4";
Order by specified the steel gauge. Ex. : RC35-XXXX-16M for a marine edge 16 GA stainless steel top.

Painted Steel Top

RC37



Serves as a work surface and protects cabinet against impacts;
Composite wood top with painted steel cover;
The top respects the CARB regulations on formaldehyde emissions;
Welded corners for attractive look;
Thickness : 1 3/4";

Galvanized Steel Top

RC36



Serves as a work surface and protects the cabinet against impacts;
Composite wood top with galvanized cover;
The top respects the CARB regulations on formaldehyde emissions;
Thickness : 1 3/4".

NOTE For compatibility with hanging side cabinet, choose top that is 12" wider than your cabinet for hanging side cabinet-side access, and 24" wider than your cabinet for hanging side cabinet-front access. Ex.: RC__-4824 for a mobile 36" W x 24" D cabinet combined with a cabinet-side access.

Dimensions		Type of Top					
W	D	Steel Top with Rubber Mat	Laminated Wood Top	Stainless Steel Top	Marine Edge Stainless Steel Top	Galvanized Steel Top	Painted Steel Top
24"	21"	RC32-2421-01					
	27"	RC32-2427-01					
30"	21"	RC32-3021-01					
	27"	RC32-3027-01	WS14-3027A*	RC35-3027-__**	RC35-3027-__M*	RC36-3027	RC37-3027
36"	18"	RC32-3618-01	WS14-3618A*				RC37-3618
	24"	RC32-3624-01	WS14-3624A	RC35-3624-__**	RC35-3624-__M*	RC36-3624	RC37-3624
48"	24"	RC32-4824-01	WS14-4824A*	RC35-4824-__**	RC35-4824-__M*	RC36-4824	RC37-4824
	27"	RC32-4827-01	WS14-4827A	RC35-4827-__**	RC35-4827-__M*	RC36-4827	RC37-4827
60"	24"	RC32-6024-01	WS14-6024A*	RC35-6024-__**	RC35-6024-__M*	RC36-6024	RC37-6024
	27"	RC32-6027-01	WS14-6027A*	RC35-6027-__**	RC35-6027-__M*	RC36-6027	RC37-6027
72"	24"	RC32-7224-01	WS14-7224A	RC35-7224-__**	RC35-7224-__M*	RC36-7224	RC37-7224
	27"	RC32-7227-01	WS14-7227A*	RC35-7227-__**	RC35-7227-__M*	RC36-7227	RC37-7227

NOTE * Please check with your customer service representative for lead time. ** 12 GA only.

For More Information: 866-333-0728

Tops Accessories

Foldaway Shelf

RC00

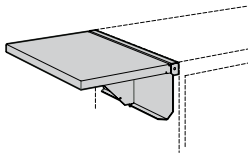

Capacity : 50 lb (evenly distributed load);
Rubber mat surface for added protection;
RC01 side stops can be installed as an option.

Product #	W x D
RC00-151801	15" x 18"
RC00-152101	15" x 21"
RC00-152401	15" x 24"
RC00-152701	15" x 27"

Side and Back Stops for Foldaway Shelf

RC01

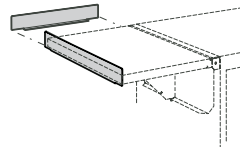

Use 15" side stop for front and back of shelf;
Use 18", 21", 24" or 27" side stop for the sides;
Height : 1".

Product #	Width
RC01-15	15"
RC01-18	18"
RC01-21	21"
RC01-24	24"
RC01-27	27"

Back and Side Stops

WS18/WS98

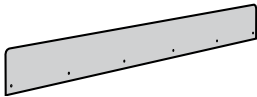

Painted steel : WS18;
Stainless steel : WS98;
Can be attached to back or sides according to top dimensions;
Install on WS14, RC35, RC36 and RC37 tops;
Height : 5". Exceeds top by approx. 3/4";
To order, complete the part # with steel choice needed.

Product #	Width	Product #	Width
WS_-2405	24"	WS_-4205	42"
WS_-2705	27"	WS_-4805	48"
WS_-3005	30"	WS_-6005	60"
WS_-3605	36"	WS_-7205	72"



R5XHD-3001

"R" Mobile Cabinet with Smart Compact Mobile "L" Cabinet

In order to determine the appropriate cabinet combination, ask yourself the following questions: What is the desired cabinet width and what is the desired capacity? Here are the possibilities:

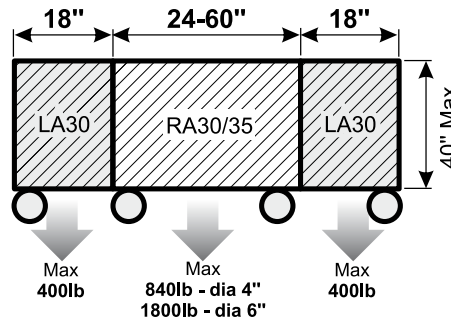
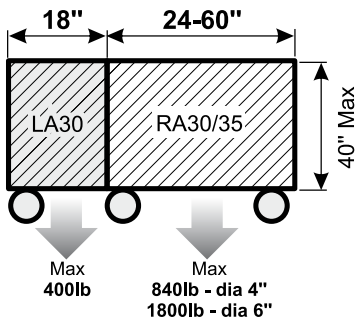

IMPORTANT With or without work surface WS08/14/16/17, RC35/36/37 (4 screws per cabinet).



The height of the cabinet should not exceed 40" in order to assure cabinet stability when it is moved.

Drawers, Roll-out Shelves and Locking or Security Mechanisms

Heavy-Duty Modular Drawer

RF31 / RF35



Drawer in painted steel : RF31;
 Drawer with stainless steel drawer front : RF35;
 400 lb capacity, 100% extension;
 Heavy-duty construction;
 Easy to install;
 Vast choice of accessories offered to adapt to your storage needs;
 Available drawer heights : 3", 4", 5", 6", 7", 8", 9", 10", 12" and 14";

SEE PAGES 161-165

Order by adding the drawer height and the desired locking mechanism to the part # and by specifying the type of drawer front (painted steel or stainless steel). Ex.: RF31-362406A;
 For modular drawers with layouts,

SEE PAGES 147-160



Product #	W x D
RF -2421	24" x 21"
RF -2427	24" x 27"
RF -3021	30" x 21"
RF -3027	30" x 27"
RF -3618	36" x 18"
RF -3624	36" x 24"

Product #	W x D
RF -4824	48" x 24"
RF -4827	48" x 27"
RF -6024	60" x 24"
RF -6027	60" x 27"

Heavy-Duty 3-Sided Access Roll-Out Shelf

RF44



400 lb capacity, 100% extension;
 Heavy-duty construction;
 Easy to install;
 Galvanized steel with 1 1/2" edge on back;
 Height : 5";

May serve as work surface;
 Order by specifying the type of locking mechanism required. Ex.: RF44-3624A.

Product #	W x D
RF44-2421	24" x 21"
RF44-2427	24" x 27"
RF44-3021	30" x 21"
RF44-3027	30" x 27"
RF44-3618	36" x 18"
RF44-3624	36" x 24"

Product #	W x D
RF44-4824	48" x 24"
RF44-4827	48" x 27"
RF44-6024	60" x 24"
RF44-6027	60" x 27"

Drawer Lock

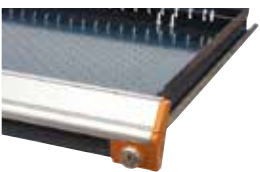

Compatible with all drawer dimensions;
 Does not affect usable drawer space;
 Easy to retrofit;
 Order by adding L3 to drawer or partitioning model number. Ex.: RF31-362406L3;
 For replacement parts or to retrofit this mechanism, order RY01-L3.

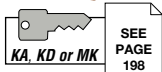

Product #
 L3

Lock-Out Mechanism

RF85



For both drawers and roll-out shelves;
 Locks drawers and roll-out shelves in open position;
 Activated manually, only when required;
 Compatible with all accessories drawer;
 Plastic bins positioned in the back row, may make it more difficult to activate mechanism.

Product #
 RF85

Heavy-Duty Front Access Roll-Out Shelf

RF40



400 lb capacity, 100% extension;
 Heavy-duty construction;
 Easy to install;
 Painted steel with 3" edges on sides and back;
 Height : 6";
 Full access to contents;
 Order by specifying the type of locking mechanism required. Ex.: RF40-3624A.

Product #	W x D
RF40-2421	24" x 21"
RF40-2427	24" x 27"
RF40-3021	30" x 21"
RF40-3027	30" x 27"
RF40-3618	36" x 18"
RF40-3624	36" x 24"

Product #	W x D
RF40-4824	48" x 24"
RF40-4827	48" x 27"
RF40-6024	60" x 24"
RF40-6027	60" x 27"

Integrated Lock-In Mechanism



Activated by tilting the handle up;
 Allows user to open the drawer and the roll-out shelf with one hand only;
 Close by simply pushing it;
 Stops drawer and roll-out shelf from opening on their own;
 Easy to retrofit;
 Order by adding A to the drawer or partitioning model number or roll-out shelf.
 Ex.: RF31-362406A;
 For replacement parts or to retrofit this mechanism, order RY08-XXA.

Product #
 A

Econo Lock-In Mechanism

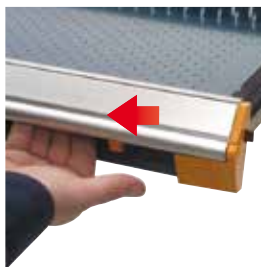

Activated with the right hand by sliding the mechanism with thumb;
 Drawer and roll-out shelf close without having to reactivate the slide mechanism;
 Stops drawer and roll-out shelf from opening on their own;
 Easy to retrofit;
 Order by adding B to the drawer or partitioning model number or roll-out shelf.
 Ex.: RF31-362406B;
 For replacement parts or to retrofit this mechanism, order RY01-B.

Product #
 B

Handle Protector

RF70



Clips onto the drawer and roll-out shelf handle;
 Made of transparent plastic;
 Protects identification labels on drawers and roll-out shelves from dust, grease and other debris;
 Easy to remove when required.

Product #	Width
RF70-24	24"
RF70-30	30"
RF70-36	36"
RF70-48	48"
RF70-60	60"

Adjustable Shelf

RB22 / RB24

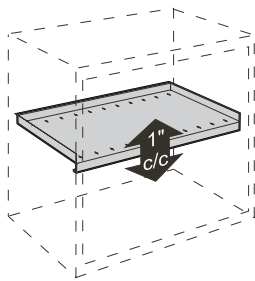

For storing bulky items;
Has edges along the sides and back to prevent items from falling into the bottom of the cabinet;
Adjustable every 1" c/c;
Up to 400 lb capacity of evenly distributed load;
SH52 dividers can be installed.

SEE PAGE 14

Product #	W x D	Capacity*
RB22-2421	24" x 21"	200
RB22-2427	24" x 27"	200
RB24-3021	30" x 21"	400
RB24-3027	30" x 27"	400
RB24-3618	36" x 18"	400
RB24-3624	36" x 24"	400
RB24-4824	48" x 24"	400
RB24-4827	48" x 27"	400
RB24-6024	60" x 24"	400
RB24-6027	60" x 27"	400

* in pounds

Bottom Shelf

RB23 / RB25

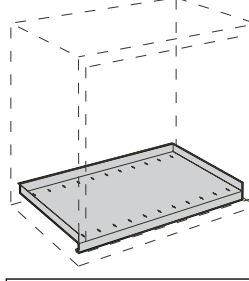

For storing bulky items;
Has edges along the sides and back to prevent items from falling into the bottom of the cabinet;
Up to 400 lb capacity of evenly distributed load;
SH52 dividers can be installed.

SEE PAGE 14

Product #	W x D	Capacity*
RB23-2421	24" x 21"	200
RB23-2427	24" x 27"	200
RB25-3021	30" x 21"	400
RB25-3027	30" x 27"	400
RB25-3618	36" x 18"	400
RB25-3624	36" x 24"	400
RB25-4824	48" x 24"	400
RB25-4827	48" x 27"	400
RB25-6024	60" x 24"	400
RB25-6027	60" x 27"	400

* in pounds

NOTE * For compatibility with double integrated doors, order an adjustable shelf.

NOTE * Perforations on top at every 3" c/c for the insertion of partial dividers SH52.

Mobility

4" Casters

RB81



Sold in pairs;
Choice of 3 types of casters : rigid, swivel, swivel with total-lock brake system (on wheel and swivel);
Capacity : 420 lb per caster;
Total height : 5 1/4";
Dark gray polyurethane tread does not mark floors. Superior industrial quality casters;
Install directly under cabinet without base.

Product #	Type of Caster
RB81-01	Rigid
RB81-02	Swivel
RB81-03	Swivel with total-lock brake system

6" Casters

RB84



Sold in pairs;
Choice of 3 types of casters : rigid, swivel, swivel with total-lock brake system (on wheel and swivel);
Capacity : 900 lb per caster;
Total height : 7 1/2";
Dark gray polyurethane tread insures silent functioning. Superior industrial quality casters;
Install directly under cabinet without base.

Product #	Type of Caster
RB84-01	Rigid
RB84-02	Swivel
RB84-03	Swivel with total-lock brake system

Extended Base for Casters

RB88

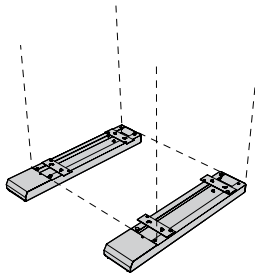

Assures cabinet stability when there are less than 4 drawers and / or when the cabinet load is not equally distributed. (Ex.: 1 drawer with 400 lb. and 3 others with 50 lb.);
Compatible with 4" and 6" casters.

Product #	Depth
RB88-18-05	18"
RB88-21-05	21"
RB88-24-05	24"
RB88-27-05	27"

6" Mag Casters

RB85



Sold in pairs
Choice of 3 types of casters: rigid, swivel, swivel with total-lock brake system (on wheel and swivel);
Aluminium wheel with durable chrome plating;
Capacity : 1000 lb per caster;
Total height : 7 1/2";
Black high grade polyurethane tread, facilitates movement. Superior industrial quality casters;
Install directly under cabinet without base.

Product #	Type of Caster
RB85-01	Rigid
RB85-02	Swivel
RB85-03	Swivel with total-lock brake system

Side Handle

RB90

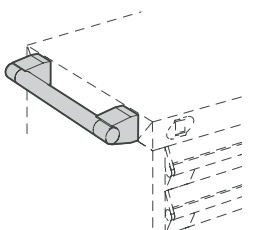

Attaches to the side of single or double cabinets : specify which side (left or right);
Anodized aluminum with durable plastic end caps;
Large handle to make moving cabinet easier.

Product #	Handle Depth	For Cabinet
RB90-18	15"	18" D
RB90-21	18"	21" D
RB90-24	21"	24" D
RB90-27	24"	27" D

Front Handles

RB92

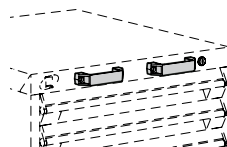

Sold in pairs;
Attach to the front of single 24" or 30" wide cabinets;
Durable plastic. Color : black.

Product #
RB92-01