

## 48" and 60" Wide (2 x 24" and 2 x 30")

Each cabinet includes one side handle and one brace to attach the cabinets.



8 drawers

R5DHG-3011	48" x 27" x 37 1/2"
R5DKG-3011	60" x 27" x 37 1/2"



7 drawers

R5DHG-3013	48" x 27" x 37 1/2"
R5DKG-3013	60" x 27" x 37 1/2"



8 drawers / 1 roll-out shelf

R5DHG-3009	48" x 27" x 37 1/2"
R5DKG-3009	60" x 27" x 37 1/2"



8 drawers / 1 door / 1 adjustable shelf / 1 bottom shelf

R5DHG-3801	48" x 27" x 45 1/2"
R5DKG-3801	60" x 27" x 45 1/2"



10 drawers

R5DHG-3809	48" x 27" x 45 1/2"
R5DKG-3809	60" x 27" x 45 1/2"



10 drawers

R5DHG-3807	48" x 27" x 45 1/2"
R5DKG-3807	60" x 27" x 45 1/2"



## Security Accessories and Recommendations

"R" MOBILE CABINET

### Vertical Security Bar

**RB10**



Lock all of the cabinet drawers with one padlock; Safety hasp is located at the top of the bar to facilitate access;  
Available to cover overall drawer heights from 24" to 34";  
Installs on the right side.

Product #	Height
RB10-24LPA	24"
RB10-26LPA	26"
RB10-30LPA	30"
RB10-34LPA	34"

### Security Panel

**RF91**

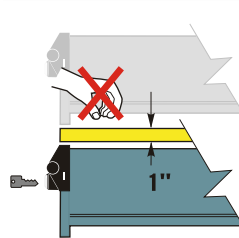

Blocks access between two drawers with locks; Usable space in cabinet reduced by 1";  
Installed between two drawers;  
Allows for the cabinet to be divided up for more than one user;  
Order by specifying the width and dept. Ex.: RF91-36 24 for a 36" W x 24" D security panel.

**Product #**  
RF91- \_\_\_\_\_

### Cabinet Lock



Allows user to lock all drawers and roll-out shelves in the cabinet at same time; Possible to change drawer and roll-out shelf positions;  
Easy to retrofit;  
Order by adding L3 to the cabinet housing number. Ex.: RA30-302758L3;  
For replacement parts or to retrofit this mechanism, order RB00-XXXXL3.

**Product #**  
L3 \_\_\_\_\_

### Cabinet Safety Hasp



Allows user to lock all drawers and roll-out shelves in the cabinet at the same time; Possible to change drawer and roll-out shelf positions;  
Alternative to the RB10 vertical security bar;  
Easy to retrofit;  
Order by adding LP to the cabinet housing number. Ex.: RA30-302758LP;  
For replacement parts or to retrofit this mechanism, order RB00-XXXXLP.

**Product #**  
LP \_\_\_\_\_

### True One-Drawer-at-a-Time System



**RB15**

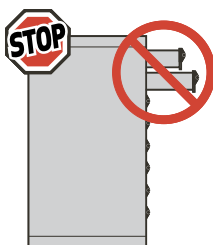

Prevents opening several drawers simultaneously. This ensures cabinet stability and protects the users;

To retrofit this mechanism, order RB15-XX-XX;

For factory installation, add A to the cabinet housing number;

One kit per cabinet.

SEE PAGE 42

Product #	Cabinet Height
RB15-28-08	28"
RB15-30-08	30"
RB15-34-10	34"
RB15-38-11	38"



Recommended for mobile cabinets and cabinets not anchored to the floor.

## "R" Double Mobile Cabinet : Appropriate Combination

In order to determine the appropriate cabinet combination, ask yourself the following questions : What is the desired cabinet width and what is the desired capacity? Here are the possibilities :

### Standard Double Cabinet

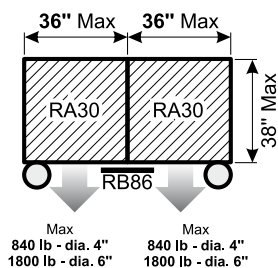

### Double Cabinet

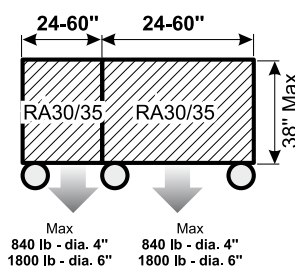

### Side Cabinet

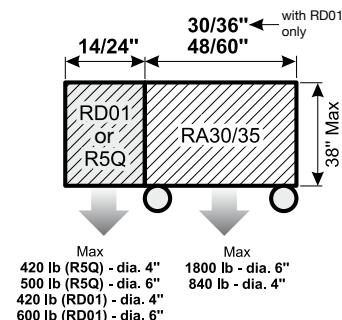

**IMPORTANT** With or without work surface WS08/14/16/17, RC35/36/37 (4 screws per cabinet).



The height of the cabinet should not exceed 38" in order to assure cabinet stability when it is moved.

For More Information: 866-333-0728

"R" MOBILE CABINET

## Hanging Side Cabinet

### Hanging Side Cabinet - Side Access

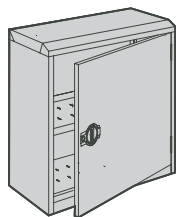

Side housing specifically designed to be installed on the side of RA30 cabinet housing;

Includes one bottom shelf;

Shelves adjustable every 1" c/c;

SH52 dividers can be installed on shelves;

Equipped with holes on the top to allow installation between one common work surface to a RA30 cabinet;

Door opens 180° for full access to items stored inside;

Door comes with standard lock;

Capacity : 600 lb;

Choice of doors. Complete the product number from the chart with the following :

01 : Solid door

02 : Polycarbonate door

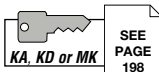

Height	Width x Depth		Number of (RD05) Adjustable Shelves
	24" x 14"	27" x 14"	
24"	R5QCA-24	R5QPA-24	-
28"	R5QCA-28	R5QPA-28	1
30"	R5QCA-30	R5QPA-30	1
34"	R5QCA-34	R5QPA-34	1
38"	R5QCA-38	R5QPA-38	2
For cabinet	24" D	27" D	



R5XHE-1001

**NOTE**

For compatibility with a work surface, choose the part number of a work surface 12" wider than your cabinet. Ex.: RC -4824 for a mobile 36" W x 24" D cabinet.

### Hanging Side Cabinet - Front Access

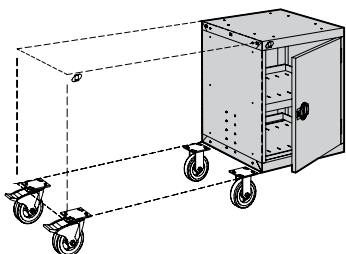

Side cabinet designed to be installed on the side of RA30 cabinet housing;

The shelves are adjustable at every 1" c/c;

SH52 dividers can be installed on both bottom and adjustable shelves;

The roll-out shelf has a capacity of 175 lb, 75% extension;

Equipped with holes on the top to allow installation between one common work surface to a RA30 cabinet;

Door opens 180°, allowing clearance space for easy handling of objects in the cabinet;

Door comes with standard lock;

Capacity : 500 lb;

Choice of configurations. Complete the number:

Bottom shelf (RB23)

and adjustable shelf(ves) (RB22) :

03 : Solid door

05 : Polycarbonate door

Roll-out shelves (RF50)

04 : Solid door

06 : Polycarbonate door

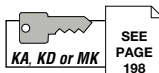
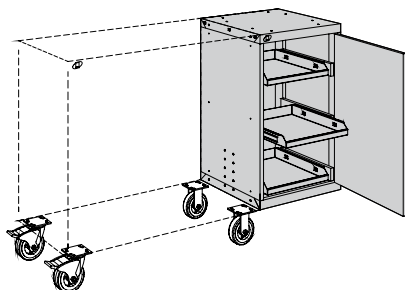

**NOTE**

For compatibility with a work surface, choose the part number of a work surface 24" wider than your cabinet.

Ex.: RC -7224 for a mobile 48" W x 24" D cabinet.



R5XRE-3001

Height	Width x Depth			Number of (RB22) Adjustable Shelves	Number of (RF50) Roll-Out Shelves
	24" x 18"	24" x 21"	24" x 24"		
28"	R5QCC-28	R5QCD-28	R5QCE-28	1	2
30"	R5QCC-30	R5QCD-30	R5QCE-30	1	2
34"	R5QCC-34	R5QCD-34	R5QCE-34	1	2
38"	R5QCC-38	R5QCD-38	R5QCE-38	2	3
For cabinet	18" D	21" D	24" D		



It is recommended to install this product on a 48" or wider.

## Cabinet Tops

### Steel Top with Rubber Mat

RC32



Non-slip rubber surface;  
Sides and back formed with a double fold : 1" high.

### Laminated Wood Top

WS14



Made from strips of laminated hardwood;  
Front 90° rounded edge for added comfort;  
Thickness : 1 3/4";  
Good impact resistance;  
Attractive appearance.

### Stainless Steel Top

RC35



16 GA stainless steel : RC35-XXXX;  
12 GA stainless steel : RC35-XXXX-12;  
Serves as a work surface and protects the cabinet against impacts;  
Particle board top with stainless steel cover (brushed finish #4);  
Excellent corrosion and chemical resistance;  
The top respects the CARB regulations on formaldehyde emissions;  
Welded corners for attractive look;  
Thickness : 1 3/4";  
To order a top in 12 GA, complete the product number with 12.

### Marine Edge Stainless Steel Top

RC35



Marine edge 16 GA stainless steel : RC35-XXXX-16M;  
Marine edge 12 GA stainless steel : RC35-XXXX-12M;  
Prevents small objects or liquids from falling or spilling from the worksurface;  
Serves as a work surface and protects cabinet against impacts;  
Composite wood top with stainless steel cover (brushed finish #4);  
Excellent corrosion and chemical resistance;  
The top respects the CARB regulations on formaldehyde emissions;  
Welded corners for attractive look;  
Thickness : 1 3/4";  
Order by specified the steel gauge. Ex. : RC35-XXXX-16M for a marine edge 16 GA stainless steel top.

### Painted Steel Top

RC37



Serves as a work surface and protects cabinet against impacts;  
Composite wood top with painted steel cover;  
The top respects the CARB regulations on formaldehyde emissions;  
Welded corners for attractive look;  
Thickness : 1 3/4";

### Galvanized Steel Top

RC36



Serves as a work surface and protects the cabinet against impacts;  
Composite wood top with galvanized cover;  
The top respects the CARB regulations on formaldehyde emissions;  
Thickness : 1 3/4".

**NOTE** For compatibility with hanging side cabinet, choose top that is 12" wider than your cabinet for hanging side cabinet-side access, and 24" wider than your cabinet for hanging side cabinet-front access. Ex.: RC\_\_-4824 for a mobile 36" W x 24" D cabinet combined with a cabinet-side access.

Dimensions		Type of Top					
W	D	Steel Top with Rubber Mat	Laminated Wood Top	Stainless Steel Top	Marine Edge Stainless Steel Top	Galvanized Steel Top	Painted Steel Top
24"	21"	RC32-2421-01					
	27"	RC32-2427-01					
30"	21"	RC32-3021-01					
	27"	RC32-3027-01	WS14-3027A*	RC35-3027-__**	RC35-3027-__M*	RC36-3027	RC37-3027
36"	18"	RC32-3618-01	WS14-3618A*				RC37-3618
	24"	RC32-3624-01	WS14-3624A	RC35-3624-__**	RC35-3624-__M*	RC36-3624	RC37-3624
48"	24"	RC32-4824-01	WS14-4824A*	RC35-4824-__**	RC35-4824-__M*	RC36-4824	RC37-4824
	27"	RC32-4827-01	WS14-4827A	RC35-4827-__**	RC35-4827-__M*	RC36-4827	RC37-4827
60"	24"	RC32-6024-01	WS14-6024A*	RC35-6024-__**	RC35-6024-__M*	RC36-6024	RC37-6024
	27"	RC32-6027-01	WS14-6027A*	RC35-6027-__**	RC35-6027-__M*	RC36-6027	RC37-6027
72"	24"	RC32-7224-01	WS14-7224A	RC35-7224-__**	RC35-7224-__M*	RC36-7224	RC37-7224
	27"	RC32-7227-01	WS14-7227A*	RC35-7227-__**	RC35-7227-__M*	RC36-7227	RC37-7227

**NOTE** \* Please check with your customer service representative for lead time. \*\* 12 GA only.

For More Information: 866-333-0728

## Tops Accessories

### Foldaway Shelf

RC00

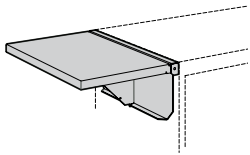

Capacity : 50 lb (evenly distributed load);  
Rubber mat surface for added protection;  
RC01 side stops can be installed as an option.

Product #	W x D
RC00-151801	15" x 18"
RC00-152101	15" x 21"
RC00-152401	15" x 24"
RC00-152701	15" x 27"

### Side and Back Stops for Foldaway Shelf

RC01

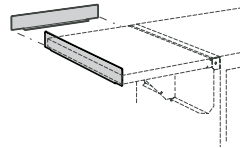

Use 15" side stop for front and back of shelf;  
Use 18", 21", 24" or 27" side stop for the sides;  
Height : 1".

Product #	Width
RC01-15	15"
RC01-18	18"
RC01-21	21"
RC01-24	24"
RC01-27	27"

### Back and Side Stops

WS18/WS98

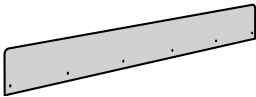

Painted steel : WS18;  
Stainless steel : WS98;  
Can be attached to back or sides according to top dimensions;  
Install on WS14, RC35, RC36 and RC37 tops;  
Height : 5". Exceeds top by approx. 3/4";  
To order, complete the part # with steel choice needed.

Product #	Width	Product #	Width
WS_-2405	24"	WS_-4205	42"
WS_-2705	27"	WS_-4805	48"
WS_-3005	30"	WS_-6005	60"
WS_-3605	36"	WS_-7205	72"



R5XHD-3001

## "R" Mobile Cabinet with Smart Compact Mobile "L" Cabinet

In order to determine the appropriate cabinet combination, ask yourself the following questions: What is the desired cabinet width and what is the desired capacity? Here are the possibilities:

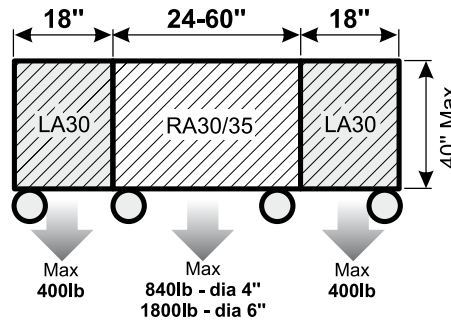
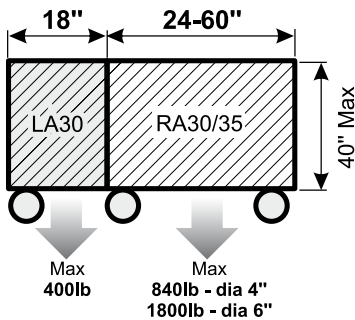

**IMPORTANT** With or without work surface WS08/14/16/17, RC35/36/37 (4 screws per cabinet).



The height of the cabinet should not exceed 40" in order to assure cabinet stability when it is moved.

## Drawers, Roll-out Shelves and Locking or Security Mechanisms

### Heavy-Duty Modular Drawer

RF31 / RF35



Drawer in painted steel : RF31;  
 Drawer with stainless steel drawer front : RF35;  
 400 lb capacity, 100% extension;  
 Heavy-duty construction;  
 Easy to install;  
 Vast choice of accessories offered to adapt to your storage needs;  
 Available drawer heights : 3", 4", 5", 6", 7", 8", 9", 10", 12" and 14";

SEE PAGES 161-165

Order by adding the drawer height and the desired locking mechanism to the part # and by specifying the type of drawer front (painted steel or stainless steel). Ex.: RF31-362406 A;  
 For modular drawers with layouts,

SEE PAGES 147-160

A lock-in mechanism (A or B) is mandatory for all mobile applications.

Product #	W x D
RF -2421	24" x 21"
RF -2427	24" x 27"
RF -3021	30" x 21"
RF -3027	30" x 27"
RF -3618	36" x 18"
RF -3624	36" x 24"

Product #	W x D
RF -4824	48" x 24"
RF -4827	48" x 27"
RF -6024	60" x 24"
RF -6027	60" x 27"

### Heavy-Duty 3-Sided Access Roll-Out Shelf

RF44



400 lb capacity, 100% extension;  
 Heavy-duty construction;  
 Easy to install;  
 Galvanized steel with 1 1/2" edge on back;  
 Height : 5";

May serve as work surface;  
 Order by specifying the type of locking mechanism required. Ex.: RF44-3624A.

Product #	W x D
RF44-2421	24" x 21"
RF44-2427	24" x 27"
RF44-3021	30" x 21"
RF44-3027	30" x 27"
RF44-3618	36" x 18"
RF44-3624	36" x 24"

Product #	W x D
RF44-4824	48" x 24"
RF44-4827	48" x 27"
RF44-6024	60" x 24"
RF44-6027	60" x 27"

### Drawer Lock

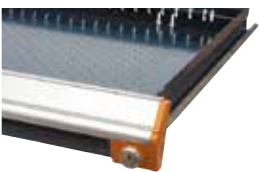

Compatible with all drawer dimensions;  
 Does not affect usable drawer space;  
 Easy to retrofit;  
 Order by adding L3 to drawer or partitioning model number. Ex.: RF31-362406L3;  
 For replacement parts or to retrofit this mechanism, order RY01-L3.

KA, KD or MK  
 SEE PAGE 198

Product #  
 L3

### Lock-Out Mechanism

RF85



For both drawers and roll-out shelves;  
 Locks drawers and roll-out shelves in open position;  
 Activated manually, only when required;  
 Compatible with all accessories drawer;  
 Plastic bins positioned in the back row, may make it more difficult to activate mechanism.

Product #  
 RF85

### Heavy-Duty Front Access Roll-Out Shelf

RF40



400 lb capacity, 100% extension;  
 Heavy-duty construction;  
 Easy to install;  
 Painted steel with 3" edges on sides and back;  
 Height : 6";  
 Full access to contents;  
 Order by specifying the type of locking mechanism required. Ex.: RF40-3624A.

Product #	W x D
RF40-2421	24" x 21"
RF40-2427	24" x 27"
RF40-3021	30" x 21"
RF40-3027	30" x 27"
RF40-3618	36" x 18"
RF40-3624	36" x 24"

Product #	W x D
RF40-4824	48" x 24"
RF40-4827	48" x 27"
RF40-6024	60" x 24"
RF40-6027	60" x 27"

### Integrated Lock-In Mechanism

PATENTED



Activated by tilting the handle up;  
 Allows user to open the drawer and the roll-out shelf with one hand only;  
 Close by simply pushing it;  
 Stops drawer and roll-out shelf from opening on their own;  
 Easy to retrofit;  
 Order by adding A to the drawer or partitioning model number or roll-out shelf.  
 Ex.: RF31-362406A;  
 For replacement parts or to retrofit this mechanism, order RY08-XXA.

Product #  
 A

### Econo Lock-In Mechanism

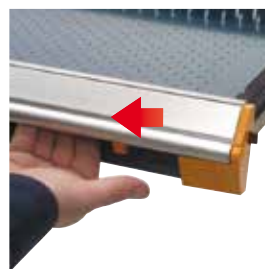

Activated with the right hand by sliding the mechanism with thumb;  
 Drawer and roll-out shelf close without having to reactivate the slide mechanism;  
 Stops drawer and roll-out shelf from opening on their own;  
 Easy to retrofit;  
 Order by adding B to the drawer or partitioning model number or roll-out shelf.  
 Ex.: RF31-362406B;  
 For replacement parts or to retrofit this mechanism, order RY01-B.

Product #  
 B

### Handle Protector

RF70



Clips onto the drawer and roll-out shelf handle;  
 Made of transparent plastic;  
 Protects identification labels on drawers and roll-out shelves from dust, grease and other debris;  
 Easy to remove when required.

Product #	Width
RF70-24	24"
RF70-30	30"
RF70-36	36"
RF70-48	48"
RF70-60	60"

## Adjustable Shelf

### RB22 / RB24

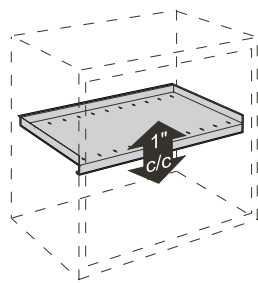

For storing bulky items;  
Has edges along the sides and back to prevent items from falling into the bottom of the cabinet;  
Adjustable every 1" c/c;  
Up to 400 lb capacity of evenly distributed load;  
SH52 dividers can be installed.

SEE PAGE 14

Product #	W x D	Capacity*
RB22-2421	24" x 21"	200
RB22-2427	24" x 27"	200
RB24-3021	30" x 21"	400
RB24-3027	30" x 27"	400
RB24-3618	36" x 18"	400
RB24-3624	36" x 24"	400
RB24-4824	48" x 24"	400
RB24-4827	48" x 27"	400
RB24-6024	60" x 24"	400
RB24-6027	60" x 27"	400

\* in pounds

## Bottom Shelf

### RB23 / RB25

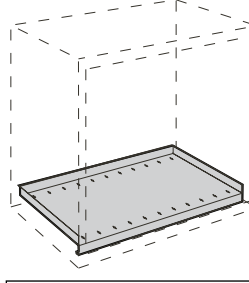

For storing bulky items;  
Has edges along the sides and back to prevent items from falling into the bottom of the cabinet;  
Up to 400 lb capacity of evenly distributed load;  
SH52 dividers can be installed.

SEE PAGE 14

Product #	W x D	Capacity*
RB23-2421	24" x 21"	200
RB23-2427	24" x 27"	200
RB25-3021	30" x 21"	400
RB25-3027	30" x 27"	400
RB25-3618	36" x 18"	400
RB25-3624	36" x 24"	400
RB25-4824	48" x 24"	400
RB25-4827	48" x 27"	400
RB25-6024	60" x 24"	400
RB25-6027	60" x 27"	400

\* in pounds

**NOTE** \* For compatibility with double integrated doors, order an adjustable shelf.

**NOTE** \* Perforations on top at every 3" c/c for the insertion of partial dividers SH52.

## Mobility

### 4" Casters

#### RB81



Sold in pairs;  
Choice of 3 types of casters : rigid, swivel, swivel with total-lock brake system (on wheel and swivel);  
Capacity : 420 lb per caster;  
Total height : 5 1/4";  
Dark gray polyurethane tread does not mark floors. Superior industrial quality casters;  
Install directly under cabinet without base.

Product #	Type of Caster
RB81-01	Rigid
RB81-02	Swivel
RB81-03	Swivel with total-lock brake system

### 6" Casters

#### RB84



Sold in pairs;  
Choice of 3 types of casters : rigid, swivel, swivel with total-lock brake system (on wheel and swivel);  
Capacity : 900 lb per caster;  
Total height : 7 1/2";  
Dark gray polyurethane tread insures silent functioning. Superior industrial quality casters;  
Install directly under cabinet without base.

Product #	Type of Caster
RB84-01	Rigid
RB84-02	Swivel
RB84-03	Swivel with total-lock brake system

### Extended Base for Casters

#### RB88

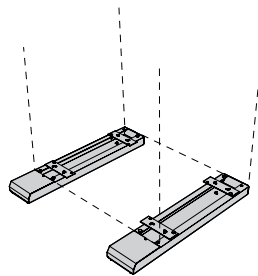

Assures cabinet stability when there are less than 4 drawers and / or when the cabinet load is not equally distributed. (Ex.: 1 drawer with 400 lb. and 3 others with 50 lb.);  
Compatible with 4" and 6" casters.

Product #	Depth
RB88-18-05	18"
RB88-21-05	21"
RB88-24-05	24"
RB88-27-05	27"

### 6" Mag Casters

#### RB85



Sold in pairs  
Choice of 3 types of casters: rigid, swivel, swivel with total-lock brake system (on wheel and swivel);  
Aluminium wheel with durable chrome plating;  
Capacity : 1000 lb per caster;  
Total height : 7 1/2";  
Black high grade polyurethane tread, facilitates movement. Superior industrial quality casters;  
Install directly under cabinet without base.

Product #	Type of Caster
RB85-01	Rigid
RB85-02	Swivel
RB85-03	Swivel with total-lock brake system

### Side Handle

#### RB90

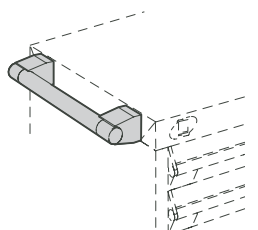

Attaches to the side of single or double cabinets : specify which side (left or right);  
Anodized aluminum with durable plastic end caps;  
Large handle to make moving cabinet easier.

Product #	Handle Depth	For Cabinet
RB90-18	15"	18" D
RB90-21	18"	21" D
RB90-24	21"	24" D
RB90-27	24"	27" D

### Front Handles

#### RB92

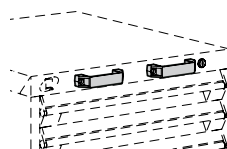

Sold in pairs;  
Attach to the front of single 24" or 30" wide cabinets;  
Durable plastic. Color : black.

Product #
RB92-01