

## “EASY GLIDER” • “POP UP BALL TRANSFERS”

“Pop Up” Ball transfers assist in transfer and positioning of materials in production. Ball transfers raise .250" above surface by activating pneumatic toggle switch. Work in process is then slid on to station. When load is in position, ball transfers are retracted and load is stabilized. Standard stations require 80 PSI of shop air to operate. Retractable ball transfer stations are available in half or full length coverage of surface. Two ball patterns are available: standard 6" x 6" pattern and heavy duty 3" x 6". Modular design allows for mounting of optional accessories. Stations feature a solid maple surface or an E.S.D., Electro Static Discharge Top. Heavy Duty 2" square tubular legs offer stability and esthetics. Leg extenders allow surface height to be set from 30" to 36". Footrest included.

**Optional foot pedal control available at an additional charge  
Not Shown**

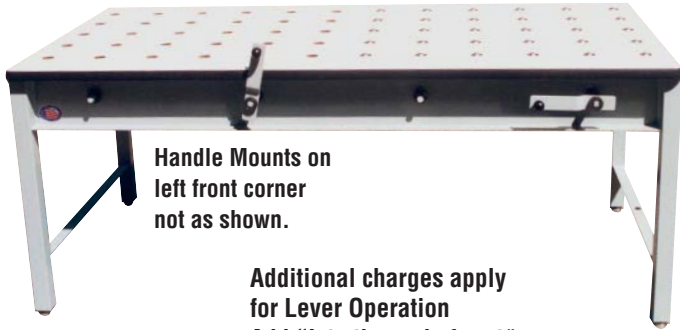

**Lever Operated Transfer Stations require no shop air.**

Handle Mounts on  
left front corner  
not as shown.

**Additional charges apply  
for Lever Operation  
Add "L to the end of part#**



Photo shown with optional accessories.

### SD-Standard Density 6" x 6" Ball Pattern

HALF COVERAGE SD	PART NO.	Wgt.	Cap. Lbs.	MAPLE  CONDUCTIVE
	RT4830HCSDM	150	200	
	RT4836HCSDM	160	200	
	RT6030HCSDM	170	200	
	RT6036HCSDM	180	200	
	RT7230HCSDM	185	200	
	RT7236HCSDM	195	200	
	RT4830HCSDC	140	200	
	RT4836HCSDC	150	200	
	RT6030HCSDC	160	200	
RT6036HCSDC	170	200		
RT7230HCSDC	175	200		
RT7236HCSDC	185	200		

FULL COVERAGE SD	PART NO.	Wgt.	Cap. Lbs.	MAPLE  CONDUCTIVE
	RT4830FCSDM	185	400	
	RT4836FCSDM	195	400	
	RT6030FCSDM	205	400	
	RT6036FCSDM	225	400	
	RT7230FCSDM	225	400	
	RT7236FCSDM	235	400	
	RT4830FCSDC	165	400	
	RT4836FCSDC	170	400	
	RT6030FCSDC	195	400	
RT6036FCSDC	175	400		
RT7230FCSDC	210	400		
RT7236FCSDC	220	400		

**M-Solid Maple HC-Half Coverage**

### HD-High Density 3" x 6" Ball Pattern

HALF COVERAGE HD	PART NO.	Wgt.	Cap. Lbs.	MAPLE  CONDUCTIVE
	RT4830HCHDM	162	400	
	RT4836HCHDM	172	400	
	RT6030HCHDM	180	400	
	RT6036HCHDM	190	400	
	RT7230HCHDM	205	400	
	RT7236HCHDM	205	400	
	RT4830HCHDC	152	400	
	RT4836HCHDC	162	400	
	RT6030HCHDC	170	400	
RT6036HCHDC	180	400		
RT7230HCHDC	195	400		
RT7236HCHDC	210	400		

FULL COVERAGE HD	PART NO.	Wgt.	Cap. Lbs.	MAPLE  CONDUCTIVE
	RT4830FCHDM	197	800	
	RT4836FCHDM	207	800	
	RT6030FCHDM	225	800	
	RT6036FCHDM	235	800	
	RT7230FCHDM	245	800	
	RT7236FCHDM	265	800	
	RT4830FCHDC	177	800	
	RT4836FCHDC	187	800	
	RT6030FCHDC	215	800	
RT6036FCHDC	187	800		
RT7230FCHDC	222	800		
RT7236FCHDC	232	800		

**C-Conductive FC-Full Coverage**

When ordering HC please specify Left or Right.

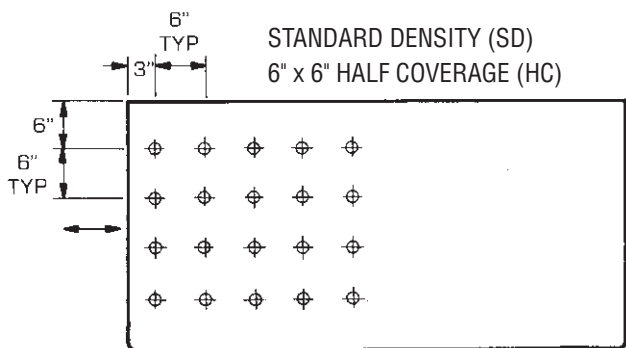

## STANDARD BALL TRANSFER LAYOUTS

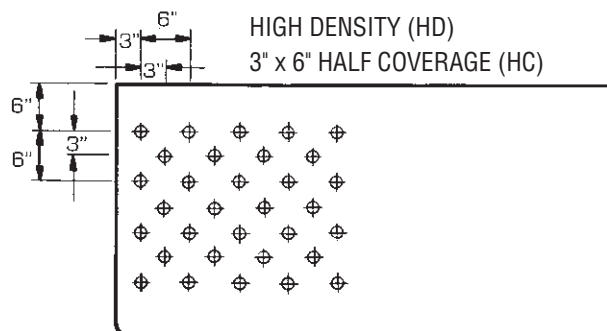

**When ordering HC half coverage please specify Transfers on Left or Right.**

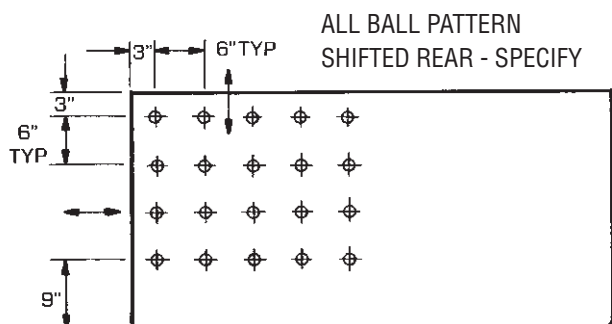
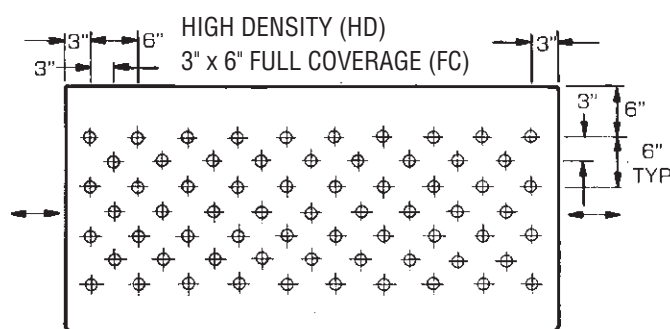
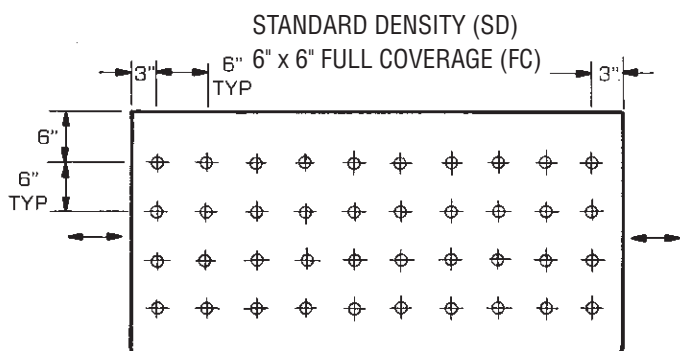

**NOTE:  
SIZES SHOWN ARE 60" x 30"  
(TOP SURFACE)**

## HEIGHT ADJUSTABLE RT STATIONS

Add hand crank or electric height adjustment to the retractable ball transfer stations. 12" adjustment standard range is from 30" to 42" (please specify) 750 lbs capacity. Upcharge price includes 4 post system and a modesty panel and footrest.

Add letters as a prefix. ie: ELHRT designates hand crank height adjustable retractable ball transfer



**ELH and ELE can be added to all four post benches except the model CPB on page 20.  
Must be ordered at time of workstation purchase.**

### ELH UPCHARGE

PART NO.	DESCRIPTION	Wgt. (lbs)
ELH	Upcharge to add 4 post Hand crank height adjustment	25
ELE	Upcharge to add 4 post Push button electric height adjustment	45

## BUILT IN GRAVITY ROLLER CONVEYOR

Do you manufacture on a progressive assembly line?

These units allow product to roll from one station to the next with a 12" x 12" Retractable Ball Transfer section in the center of the surface. 1" dia. x 12"L Rollers are set on 3" centers on either side of ball transfers. Transfers, when up, are set at same height as roller which allows product to be rotated. 200 lbs. capacity. Priced with standard laminate work surface.

Please consult factory for other work surface choices

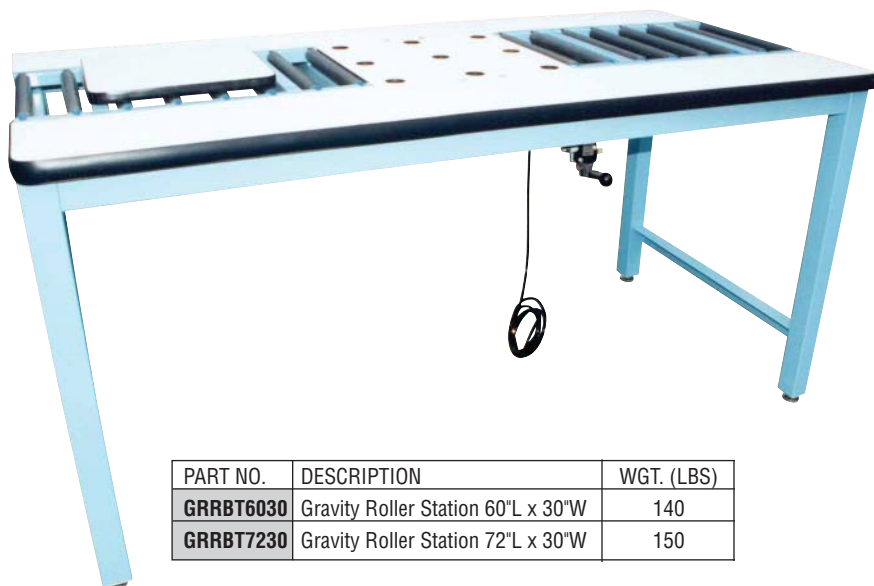

PART NO.	DESCRIPTION	WGT. (LBS)
GRRBT6030	Gravity Roller Station 60"L x 30"W	140
GRRBT7230	Gravity Roller Station 72"L x 30"W	150

## FIXED BALL TRANSFER TABLES

Fixed Ball Transfer Tables with ball casters surface mounted or recessed to match level of RBT unit also available. **(Shown with optional casters, making the cart mobile.)** 1000 lbs. capacity.

Priced with standard laminate work surface. Please consult factory for other work surface choices

**Optional handle available at an additional charge**



**For Optional Casters See Page 40**

### HIGH DENSITY

PART NO.	DESCRIPTION	Wgt. (lbs)
BT483030-HD	48"L x 30"W 3x6 121.92cm x 76.20cm x 76.20cm	128
BT483630-HD	48"L x 36"W 3x6 121.92cm x 91.44cm x 76.20cm	145
BT603030-HD	60"L x 30"W 3x6 152.40cm x 76.20cm x 76.20cm	153
BT603630-HD	60"L x 36"W 3x6 152.40cm x 91.44cm x 76.20cm	172
BT723030-HD	72"L x 30"W 3x6 182.88cm x 76.20cm x 76.20cm	170
BT723630-HD	72"L x 36"W 3x6 182.88cm x 91.44cm x 76.20cm	197

### STANDARD DENSITY

PART NO.	DESCRIPTION	Wgt. (lbs)
BT483030-SD	48"L x 30"W 6x6 121.92cm x 76.20cm x 76.20cm	117
BT483630-SD	48"L x 36"W 6x6 121.92cm x 91.44cm x 76.20cm	128
BT603030-SD	60"L x 30"W 6x6 152.40cm x 76.20cm x 76.20cm	135
BT603630-SD	60"L x 36"W 6x6 152.40cm x 91.44cm x 76.20cm	150
BT723030-SD	72"L x 30"W 6x6 182.88cm x 76.20cm x 76.20cm	154
BT723630-SD	72"L x 36"W 6x6 182.88cm x 91.44cm x 76.20cm	176

# SECTION IV

# ACCESSORIES

**NOTE:** When ordering accessories only, please indicate the model they are mounting to.  
**Example:** For a shelf with a Flexline Station use CSPL1260PL FL.

## UPRIGHTS

Universal Uprights accept all accessories which would be suspended above work surface. Features infinite adjustability and self tightening hardware. Complete with mounting hardware. Priced per pair.

PART NO.	DESCRIPTION	Wgt. (lbs)
<b>UR24</b>	Uprights 24"/60.96cm (12" Above Surface)	8
<b>UR36</b>	Uprights 36"/91.44cm (24" Above Surface)	10
<b>UR48</b>	Uprights 48"/121.92cm (36" Above Surface)	15
<b>UR60</b>	Uprights 60"/152.40cm (48" Above Surface)	20
<b>UR72</b>	Uprights 72"/182.82cm (60" Above Surface)	25

UR 72 only are 3.25" Thick.  
 All others 1.625" as shown



## HEAVY DUTY UPRIGHTS

Constructed from the same material as our standard uprights, these uprights are double thick. Designed for placing heavy items on multiple shelves and mounting accessories behind station, chatter shields or a shelf, for example. HDUR60 are 60"L and extend up to 48" above surface. Sold in pairs.

PART NO.	DESCRIPTION	WGT. (LBS)
<b>HDUR60</b>	1.625" x 3.250" x 60" uprights extend 48" above surface.	40

ACCESSORIES

## SPLIT UPRIGHT SYSTEM

Mounts to most Pro-Line Stations. Price includes 4 UR60 and 1 lower upright support. Extends 48" above surface.

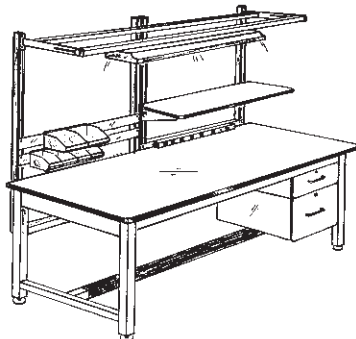

PART NO.	DESCRIPTION	Wgt. (lbs)	Wgt. (cap)
<b>SURS48</b>	Split Upright System for 48" Bench	19.5	8.8
<b>SURS60</b>	Split Upright System for 60" Bench	20.5	9.3
<b>SURS72</b>	Split Upright System for 72" Bench	21.5	9.7
<b>SURS96</b>	Split Upright System for 96" Bench	25	11.3



Note: When ordering accessories for the split upright system, please add /SURS to the part number.  
 For example- ESMR60/SURS

## LOUVERED PANELS (FOR HANGING BINS)

These 34" high louvered panels consist of (2) 17" peices and are steel construction. Panels are painted to match frame.

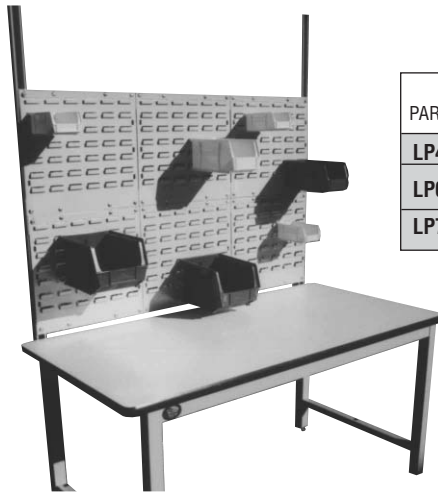

PART NO.	DESCRIPTION	Wgt. (lbs)	Wgt. (cap)
LP4834	Fits 48" Workstation	26	100
LP6034	Fits 60" Workstation	36	150
LP7234	Fits 72" Workstation	48	175

For other sizes,  
Please consult factory

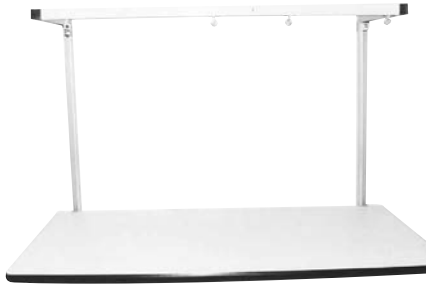

PART NO.	DESCRIPTION	Wgt. (lbs)	Wgt. (cap)
TSF1248	Tool Trolley Frame 12"W 48"L 30.48cm x 121.92cm Projection	12	75
TSF1260	Tool Trolley Frame 12"W 60"L 30.48cm x 152.40cm Projection	13	75
TSF1272	Tool Trolley Frame 12"W 72"L 30.48cm x 182.88cm Projection	14	75
TSF1296	Tool Trolley Frame 12"W 96"L 30.48cm x 243.84cm Projection	16	75

## TOOL SUSPENSION FRAME I

Welded channel frame allows mounting of one or more tools with full length sliding capability. **(Not required if overhead light frame is purchased.)** Tool balancers and torque arms can then be utilized. Price includes 2 Tool Trolleys.



PART NO.	DESCRIPTION	Wgt. (lbs)	Wgt. (cap)
TSF1848	Tool Trolley Frame 18"W 48"L 45.76cm x 121.92cm Projection	13	75
TSF1860	Tool Trolley Frame 18"W 60"L 45.76cm x 152.40cm Projection	14	75
TSF1872	Tool Trolley Frame 18"W 72"L 45.76cm x 182.88cm Projection	15	75
TSF1896	Tool Trolley Frame 18"W 96"L 45.76cm x 243.84cm Projection	17	75

## TOOL SUSPENSION FRAME II

This "Tool Suspension Frame" mounts directly into our "Overhead Light Frame." Tool balancers and torque arms can then be utilized. Tool Frame adjustable back and forward, full extension 24" over surface. Price includes 2 Tool Trolleys. **Extra Trolleys priced seperately. Part# ETT**

PART NO.	DESCRIPTION	Wgt. (lbs)	Wgt. (cap)
LTF48	Fits 48" Bench	12	75
LTF60	Fits 60" Bench	13	75
LTF72	Fits 72" Bench	14	75
LTF96	Fits 96" Bench	16	75

## OVERHEAD LIGHT FRAME

Includes structural steel light mounting frame, (1) dual bulb fluorescent fixture with 9' powercord and on/off switch.

The new 3 way adjustable light allows adjustment of lighting front to back over worksurfaces as well as swivel capability. Comes complete with lock knobs. Rear support also functions as fixed tool balancer slide trolley.

OLF48 Comes standard with a T-8 Ballast, Optional on other lights

**Center of light extrudes up to 24" from back of station. Bulbs not included.**

**For voltage requirements outside USA, additional charges apply. Please specify which country.**

PART NO.	DESCRIPTION	Wgt. (lbs)	Wgt. (kgs)
OLF48	Mounts on 48"L/121.92cm Station	21	9.5
OLF60	Mounts on 60"L/152.40cm Station	27	12.2
OLF72	Mounts on 72"L/182.88cm Station	38	17.2
OLF96	Mounts on 96"L/243.84cm Station	45	20.4



### ADDITIONAL CHARGE FOR DELUXE FIXTURE

ADD LETTER "D" TO PART# FOR DELUXE. ie:OLF60D



**Parabolic lens available on deluxe fixture only, add "P" to part # ie: OLF60DP.**

**Under shelf / Under cabinet lighting  
Part# LT48...See page 57 for example**



## FOOTREST

Heavy gauge steel painted to match frame – adds greater comfort and less fatigue for the operator. Shown with optional guard (priced on graph below).

PART NO.	DESCRIPTION	Wgt. (lbs)	Wgt. (kgs)
FR48	Fits 48"L/121.92cm Station	5	2.2
FR60	Fits 60"L/152.40cm Station	6¼	2.8
FR72	Fits 72"L/182.88cm Station	7½	3.4
FR96	Fits 96"L/243.84cm Station	10	4.5

## FOOTREST GUARD

Black vinyl cover for the footrest is additional, adds comfort and enhanced appearance.

PART NO.	DESCRIPTION	Wgt. (lbs)	Wgt. (kgs)
FRG48	Vinyl Guard for 48"L/121.92cm Station	4	1.8
FRG60	Vinyl Guard for 60"L/152.40cm Station	5	2.2
FRG72	Vinyl Guard for 72"L/182/99cm Station	6	2.7
FRG96	Vinyl Guard for 96"L/243.84cm Station	8	3.6



Drawer Faces white only

## MODULAR DRAWER SYSTEM (TOP QUALITY ROUNDED EDGE MODEL)

Features rounded T mold corners to match top for operator protection at knee level. Modular concept allows independent design for easy configuration throughout plant. Durable steel body with quality T mold edged laminate face, smooth drawer action on ball bearings. Requires one mounting bracket per workstation. Dim. of Drawers 15"W x 19¼"D.

\*PRICE INCLUDES LOCK

When ordering drawers alone, please add model# as suffix Example: HK/EL. Different models require their own hanging kits.

PART NO.	DESCRIPTION	Wgt. (lbs)	Wgt. (kgs)
MDS-3	3"H/7.62cm Drawer Unit	20	9
MDS-6	6"H/16.24cm Drawer Unit	26	11.8
MDS-9	9"H/22.86cm Drawer Unit	32	14.5
MDS-12	12"H/30.48cm Drawer Unit	38	17.2
HK	Drawer Hanging Kit	1.15	.52

HK also required on POWS, KOS, DP-1, and CPU.  
\*All drawers are keyed differently unless specified

## 20 AMP ELECTRICAL SUPPLY (20A, 125V)

Includes 6 or 8 outlets, standard on/off switch, indicator light, resettable circuit breaker and 6' cord. Mounting is identical to our standard electrical supply.

NOTE: Other 20 amp configurations available upon request.

PART NO.	DESCRIPTION	Wgt. (lbs)	Wgt. (kgs)
ES36/20 6 outlets	20 AMP Electrical Supply 36"L/50.80cm x 91.44cm	4¼	1.9
ES48/20 8 outlets	20 AMP Electrical Supply 48"L/50.80cm x 121.96cm	5¼	2.3

## STANDARD ELECTRICAL SUPPLY (15A, 125V)

Includes 12 outlets, on/off switch, on indicator light, resettable circuit breaker, 6' cord, mounts to electrical supply mounting rail (which is fully adjustable on uprights) or to worksurfaces, frame, etc. Electrical supplies punched and wired directly into the workstation frame are available upon request.

NOTE: Pro-Line can match any electrical or other utility specifications you may have.



For 48" Long Stations  
Use ES36

PART NO.	DESCRIPTION	Wgt. (lbs)	Wgt. (kgs)
ES12	12"L/30.48cm (6) Outlet Powerstrip	1¼	.8
ES36	36"L/91.44cm (9) Outlet Powerstrip	3½	1.5
ES48	48"L/121.92cm (12) Outlet Powerstrip	4½	2

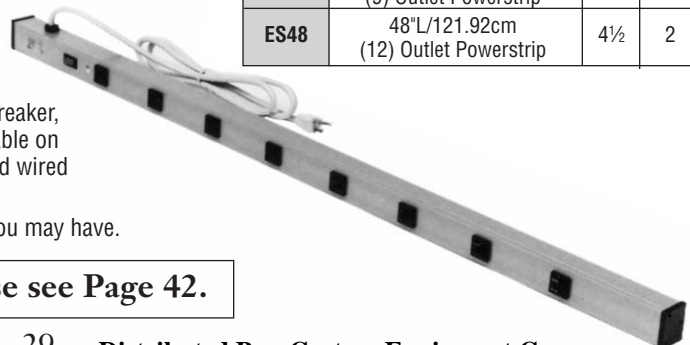

For voltage requirements outside USA, please see Page 42.

## ELECTRICAL SUPPLY MOUNTING RAIL

Heavy gauge formed steel allows electrical supply to mount to upright system. 2 knockouts allow airquick disconnect to be added.

PART NO.	DESCRIPTION	Wgt. (lbs)	Wgt. (kgs)
ESMR24	Fits 24"/60.96cm Upright System	1¼	.8
ESMR30	Fits 30"/76.20cm Upright System	2¾	1.2
ESMR36	Fits 36"/91.44cm Upright System	3	1.3
ESMR48	Fits 48"/121.92cm Upright System	3¾	1.4
ESMR60	Fits 60"/152.40cm Upright System	4	1.8
ESMR72	Fits 72"/182.88cm Upright System	5	2.2
ESMR96	Fits 96"/243.84cm Upright System	7	3.1



## AIRQUICK DISCONNECT

These air fittings easily mount into receptacle at either end of electrical supply mounting rail. Easily accessible yet keeps worksurface clear of hoses when pneumatic tools are in use.

PART NO.	DESCRIPTION	Wgt. (lbs)	Wgt. (kgs)
AQDC	Mounts on ESMR	1½	.6

## LEG EXTENDERS

Formed steel channel sleeves into bottom of each leg to adjust height in 1" increments. Standard size allows 6" of adjustment. **Set of 4.**

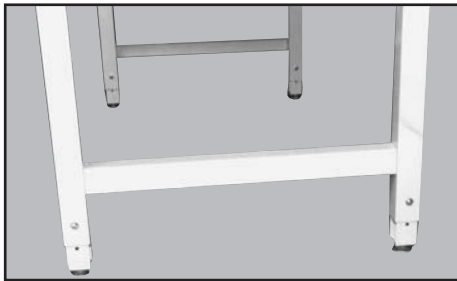

PART NO.	DESCRIPTION	Wgt. (lbs)	Wgt. (kgs)
HDLE-6	6"/15.24cm Leg Adjusters	8	3.6

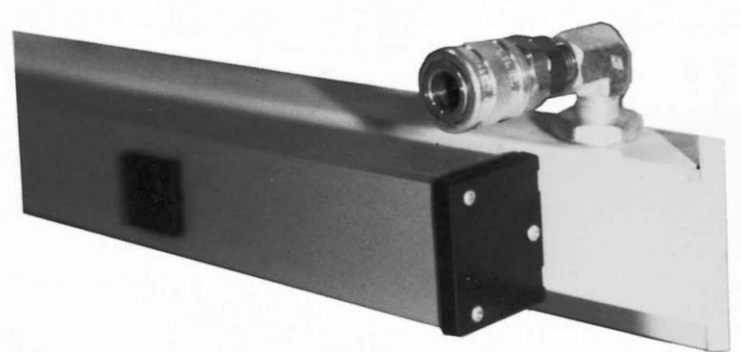

## TOOL BALANCER HOLDER

Mounts to any vertical upright. Channel construction allows tool hook to slide front to back. Standard sizes: TH8" – TH12" – TH18".

Tool balancer hooks onto tool hook.

PART NO.	DESCRIPTION	Wgt. (lbs)	Wgt. (kgs)
TH-8	Mounts to Uprights 8"/20.32cm Projection	2	9.55
TH-12	Mounts to Uprights 12"/30.48cm Projection	3	14.09
TH-18	Mounts to Uprights 18"/45.72cm Projection	4	18.64

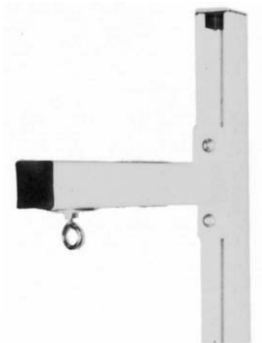

## BACK GUARD

3" H guard prevents items from rolling off back of worksurface.

PART NO.	DESCRIPTION	Wgt. (lbs)	Wgt. (kgs)
BSS48	Mounts on Surface 48"L/121.92cm	4½	2
BSS60	Mounts on Surface 60"L/152.40cm	5¾	2.6
BSS72	Mounts on Surface 72"L/182.88cm	7	3.1
BSS96	Mounts on Surface 96"L/243.84cm	9½	4.5

## END GUARD

3"H guard prevents items from rolling off ends of worksurface. Priced per pair.

PART NO.	DESCRIPTION	Wgt. (lbs)	Wgt. (kgs)
ESS24	Mounts on Surface 24"W/60.96cm	2¼	1
ESS30	Mounts on Surface 30"W/76.20cm	3	1.3
ESS36	Mounts on Surface 36"W/91.44cm	3½	1.5



## WIRE SPOOL HOLDER

1" diameter rod holds wire or packaging dispenser spools. Adjustable front to rear

PART NO.	DESCRIPTION	Wgt. (lbs)	Wgt. (kgs)
WSH48	Hold Wire Spool Reels 48"L/121.92cm	11	5
WSH60	Holds Wire Spool Reels 60"L/152.40cm	12	5.45
WSH72	Holds Wire Spool Reels 72"L/182.88cm	13	5.91
WSH96	Holds Wire Spool Reels 96"L/243.84cm	15	6.82

Capacity 100 LB.



## PURSE HOLDER

Open back and front storage when security is not required.

PART NO.	DESCRIPTION	Wgt. (lbs)	Wgt. (kgs)
PHB-1	10"W x 18"D x 12"H (Steel) 25.40cm x 45.72cm x 30.48cm	13	5.91

## PURSE HOLDER WITH BACK

Same as above, with back

PART NO.	DESCRIPTION	Wgt. (lbs)	Wgt. (kgs)
PHB-2	10"W x 18"D x 12"H (Steel) 25.40cm x 45.72cm x 30.48cm	15.5	7.05



## SLIDING DOOR CABINET

Sliding Door Cabinets are 14.5" x 13.75" ID. Cabinets come complete with a lock and mounting brackets. They are ideal for manual storage, components, or personal storage. 200 LB. capacity

PART NO.	DESCRIPTION	Wgt. (lbs)
SDC48	Sliding Door Cabinet 48"L	64
SDC60	Sliding Door Cabinet 60"L	80
SDC72	Sliding Door Cabinet 72"L	72

**Note:**  
SDC should be mounted with back to back HDUR. See page 27 or UR72

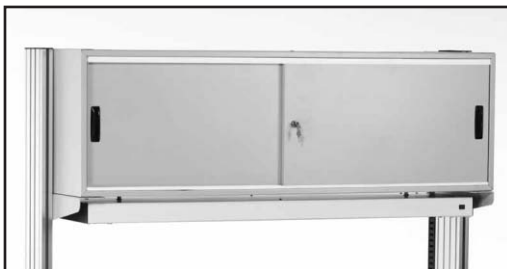

Standard Cabinet supplied with sliding steel doors.

Also available with Lexan® sliding doors, glass doors or steel flipper doors

\*Textured Paint Only\*

See page 52 for available Textured colors

## BIN HOLDER

Heavy gauge formed steel mounts to upright system for unlimited adjustment of bins

PART NO.	DESCRIPTION	Wgt. (lbs)	Wgt. (kgs)
BH24	Fits 24"/60.96cm Upright System	2¼	.8
BH30	Fits 30"/76.20cm Upright System	2½	1.1
BH36	Fits 36"/91.44cm Upright System	3½	1.5
BH48	Fits 48"/121.92cm Upright System	4½	2
BH60	Fits 60"/152.40cm Upright System	5½	2.4
BH72	Fits 72"/182.88cm Upright System	6½	2.8
BH96	Fits 96"/243.84cm Upright System	7½	3.2

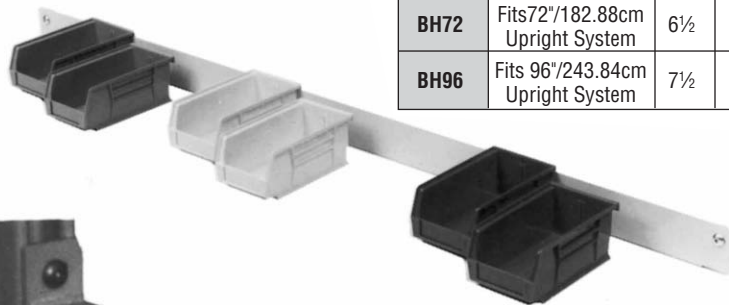

## LAZY SUSAN

18" diameter, 4 position turntable for a wide variety of applications. Other sizes available upon request. 200 lbs capacity. **Min. order 3 units.** 2.53" H.

PART NO.	DESCRIPTION	Wgt. (lbs)	Wgt. (kgs)
LS18-16	Plastic Laminated Turntable 18" Diameter	12	5.45

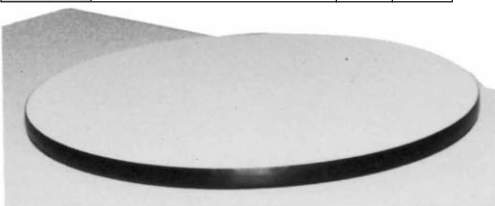

## MAGNIFIER LIGHT BRACKET

Bracket mounts to upright at any height for mounting of magnification lights, document holders, etc.

PART NO.	DESCRIPTION	Wgt. (lbs)	Wgt. (kgs)
LOMB	Mounts to Uprights	1	.4





## MODESTY PANEL (STEEL)

Steel panel painted to match frame. Encloses rear of workstation. 21"H

PART NO.	DESCRIPTION	Wgt. (lbs)	Wgt. (kgs)
MP48	Mounts on 48"L/121.92cm Station	19	8.6
MP60	Mounts on 60"L/152.40cm Station	23½	10.6
MP72	Mounts on 72"L/182.88cm Station	28	12.7
MP96	Mounts on 96"L/243.84cm Station	37½	43.6



## MODESTY PANEL (PLASTIC LAMINATE)

Modesty Panel plastic laminate. Encloses rear of frame. 21"H

PART NO.	DESCRIPTION	Wgt. (lbs)	Wgt. (kgs)
MPP48	Mounts on 48"L/121.92cm Station	15	6.8
MPP60	Mounts on 60"L/152.40cm Station	18¾	8.5
MPP72	Mounts on 72"L/182.88cm Station	22½	10.2
MPP96	Mounts on 96"L/243.84cm Station	30	13.6



## END PANEL (STEEL)

Steel panel painted to match frame. Encloses one or both ends of workstation. Priced each.

PART NO.	DESCRIPTION	Wgt. (lbs)	Wgt. (kgs)
EP24	Mounts on 24"W/60.96cm Station	11	5
EP30	Mounts on 30"W/76.20cm Station	14	6.3
EP36	Mounts on 36"W/91.44cm Station	17	7.7



## END PANEL (PLASTIC LAMINATE)

End Panel plastic laminate. Encloses one or both ends of workstation. Priced each.

PART NO.	DESCRIPTION	Wgt. (lbs)	Wgt. (kgs)
EPP24	Mounts on 24"W/60.96cm Station	10	4.5
EPP30	Mounts on 30"W/76.20cm Station	12½	5.6
EPP36	Mounts on 36"W/91.44cm Station	15	6.8



## CANTILEVER SHELF (PLASTIC LAMINATE)

Includes (1) 12" or 18" wide plastic laminate shelf and shelf supports for each upright – infinitely adjustable. 125 lb capacity per shelf.

BASE PART NO./SIZE	PLASTIC LAMINATE		E.S.D. LAMINATE		SOLID 1¼" MAPLE	
	Wgt. (lbs)	Wgt. (kgs)	Wgt. (lbs)	Wgt. (kgs)	Wgt. (lbs)	Wgt. (kgs)
<b>CSPL1224</b> 12" x 24" (30.4cm x 60.7cm)	<b>CSPL1224PL</b>		<b>CSPL1224ESD</b>		<b>CSPL1224SM</b>	
	12	5.4	12	5.4	12	5.4
<b>CSPL1230</b> 12" x 30" (30.4cm x 76.2cm)	<b>CSPL1230PL</b>		<b>CSPL1230ESD</b>		<b>CSPL1230SM</b>	
	15	6.8	15	6.8	15	6.8
<b>CSPL1236</b> 12" x 36" (30.4cm x 91.4cm)	<b>CSPL1236PL</b>		<b>CSPL1236ESD</b>		<b>CSPL1236SM</b>	
	18	8.1	18	8.1	18	8.1
<b>CSPL1248</b> 12" x 48" (30.4cm x 121.9cm)	<b>CSPL1248PL</b>		<b>CSPL1248ESD</b>		<b>CSPL1248SM</b>	
	24	10.9	24	10.9	24	10.9
<b>CSPL1260</b> 12" x 60" (30.4cm x 152.4cm)	<b>CSPL1260PL</b>		<b>CSPL1260ESD</b>		<b>CSPL1260SM</b>	
	30	13.6	30	13.6	30	13.6
<b>CSPL1272</b> 12" x 72" (30.4cm x 182.8cm)	<b>CSPL1272PL</b>		<b>CSPL1272ESD</b>		<b>CSPL1272SM</b>	
	36	16.3	36	16.3	36	16.3
<b>CSPL1296</b> 12" x 96" (30.4cm x 243.8cm)	<b>CSPL1296PL</b>		<b>CSPL1296ESD</b>		<b>CSPL1296SM</b>	
	42	19	42	19	42	19
<b>CSPL1824</b> 18" x 24" (45.7cm x 76.2cm)	<b>CSPL1824PL</b>		<b>CSPL1824ESD</b>			
	17	7.6	17	7.6		
<b>CSPL1830</b> 18" x 30" (45.7cm x 76.2cm)	<b>CSPL1830PL</b>		<b>CSPL1830ESD</b>			
	22	10.1	22	10.1		
<b>CSPL1836</b> 18" x 36" (45.7cm x 91.4cm)	<b>CSPL1836PL</b>		<b>CSPL1836ESD</b>			
	26	11.9	26	11.9		
<b>CSPL1848</b> 18" x 48" (45.7cm x 121.9cm)	<b>CSPL1848PL</b>		<b>CSPL1848ESD</b>			
	31	13.9	31	13.9		
<b>CSPL1860</b> 18" x 60" (45.7cm x 152cm)	<b>CSPL1860PL</b>		<b>CSPL1860ESD</b>			
	35	16	35	16		
<b>CSPL1872</b> 18" x 72" (45.7 x 182.8cm)	<b>CSPL1872PL</b>		<b>CSPL1872ESD</b>			
	40	18	40	18		
<b>CSPL1896</b> 18" x 96" (45.7cm x 243.8cm)	<b>CSPL1896PL</b>		<b>CSPL1896ESD</b>			
	44	20.1	44	20.1		

**PLEASE CONSULT THE FACTORY FOR ALL YOUR CUSTOM FABRICATION REQUIREMENTS**

### PLEASE NOTE:

When ordering accessories, the model number that the accessory is mounting to must be indicated.

**Example:** A shelf mounting to a FlexLine station would use a part #CSPL1260PLFL for the 60" Flexline work station.

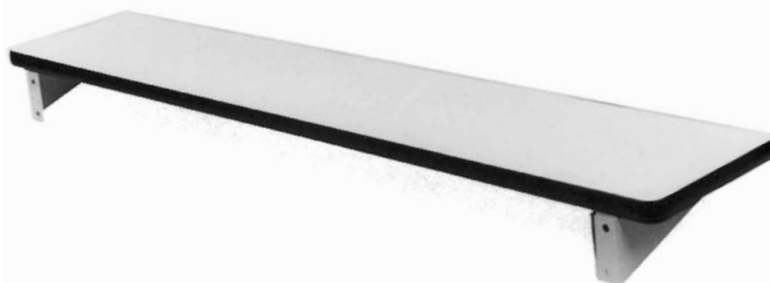

### ADJUSTABLE METAL SHELF

Rigid steel shelf painted to match frame. Easily adjusts from flat to 30° incline position.

PART NO.	DESCRIPTION	Wgt. (lbs)	Wgt. (cap)
<b>AMS1224</b>	24"W x 12"D	10	70
<b>AMS1230</b>	30"W x 12"D	12.5	70
<b>AMS1236</b>	36"W x 12"D	15	70
<b>AMS1248</b>	48"W x 12"D	22.25	75
<b>AMS1260</b>	60"W x 12"D	27.25	95
<b>AMS1272</b>	72"W x 12"D	32½	105
<b>AMS1824</b>	24"W x 18"D	15	70
<b>AMS1830</b>	30"W x 18"D	17.5	70
<b>AMS1836</b>	36"W x 18"D	20	70
<b>AMS1848</b>	48"W x 18"D	29.25	75
<b>AMS1860</b>	60"W x 18"D	35.00	95
<b>AMS1872</b>	72"W x 18"D	41	105



# WIRE CANTILEVER SHELF

PART NO.	DESCRIPTION	Wgt. (lbs)
WCS12-24	12"W/30.48cm x 60.96cm Fits 24" Upright System	5
WCS12-30	12"W/30.48cm x 76.20cm Fits 30" Upright System	6
WCS12-36	12"W/30.48cm x 91.44cm Fits 36" Upright System	7
WCS12-48	12"W/30.48cm x 121.92cm Fits 48" Upright System	9½
WCS12-60	12"W/30.48cm x 152.40cm Fits 60" Upright System	12
WCS12-72	12"W/30.48cm x 182.88cm Fits 72" Upright System	15

12" deep straight

## 16" deep straight

PART NO.	DESCRIPTION	Wgt. (lbs)
WCS16-24	16"W/45.72cm x 60.96cm Fits 24" Upright System	6½
WCS16-30	16"W/45.72cm x 76.20cm Fits 30" Upright System	8
WCS16-36	16"W/45.72cm x 91.44cm Fits 36" Upright System	10
WCS16-48	16"W/45.72cm x 121.92cm Fits 48" Upright System	12½
WCS16-60	16"W/45.72cm x 152.40cm Fits 60" Upright System	16
WCS16-72	16"W/45.72cm x 182.88cm Fits 72" Upright System	21

16" deep straight

# SLANTED WIRE CANTILEVER SHELF

Same as WCS but set at slant 15°. Slanted shelf pricing includes steel front lip

PART NO.	12" deep slanted DESCRIPTION	Wgt. (lbs)
SWCS12-24	Slanted 12" W Fits 24" Upright Sys./30.48cm x 60.96cm	6
SWCS12-30	Slanted 12" W Fits 30" Upright Sys./30.48cm x 72.20cm	7
SWCS12-36	Slanted 12" W Fits 36" Upright Sys./30.48cm x 91.44cm	8
SWCS12-48	Slanted 12" W Fits 48" Upright Sys./30.48cm x 121.92cm	10
SWCS12-60	Slanted 12" W Fits 60" Upright Sys./30.48cm x 152.40cm	14
SWCS12-72	Slanted 12" W Fits 72" Upright Sys./30.48cm x 182.88cm	16

12" deep slanted

PART NO.	DESCRIPTION	Wgt. (lbs)
SWCS16-24	Slanted 16" W Fits 24" Upright Sys./45.72cm x 60.96cm	8
SWCS16-30	Slanted 16" W Fits 30" Upright Sys./45.72cm x 76.20cm	10
SWCS16-36	Slanted 16" W Fits 36" Upright Sys./45.72cm x 91.44cm	12
SWCS16-48	Slanted 16" W Fits 48" Upright Sys./45.72cm x 121.92cm	14
SWCS16-60	Slanted 16" W Fits 60" Upright Sys./45.72cm x 152.40cm	17
SWCS16-72	Slanted 16" W Fits 72" Upright Sys./45.72cm x 182.88cm	23

16" deep slanted

ACCESSORIES

- \*Fully adjustable to any height on the upright
- \*Wire design allows for better lighting and a dust free surface
- \*Durable Powder Coat Finish

# PULL OUT WRITING SHELF

Steel writing surface 12"W x 18"D. 30 lbs. capacity.



PART NO.	DESCRIPTION	Wgt. (lbs)	Wgt. (kgs)
POWS	Pull Out Shelf 12"W x 18"D 30.48cm x 45.72cm	12	5.45



Note: Both POWS and KOS require one HK Hanging Kit. Additional charge applies



Shelving and brackets available in textured black only.

# PULL OUT KEYBOARD

Powder coat painted steel

PART NO.	DESCRIPTION	Wgt. (lbs)	Wgt. (kgs)
KOS	Pull Out Keyboard Shelf 12"D x 19¾"L x 2.5 Clearance	16	7.2



## STANDARD LOWER SHELF

Heavy gauge formed shelf painted to match frame – 12" wide with a load capacity of 150 lbs.

Actual Depth 12"		Wgt. (lbs)	Wgt. (kgs)
PART NO.	DESCRIPTION		
HDLS48-12	12"W Fits 48"L Unit 30.48cm x 121.92 cm	15	6.8
HDLS60-12	12"W Fits 60"L Unit 30.48cm x 152.40 cm	18¾	8.5
HDLS72-12	12"W Fits 72"L Unit 30.48cm x 182.88 cm	22½	10.2
HDLS96-12	12"W Fits 96"L Unit 30.48cm x 243.84 cm	30	13.6

Actual Depth 18"		Wgt. (lbs)	Wgt. (kgs)
PART NO.	DESCRIPTION		
HDLS48-18	18"W Fits 48"L Unit 45.72cm x 121.92 cm	20	9
HDLS60-18	18"W Fits 60"L Unit 45.72cm x 152.40 cm	25	11.3
HDLS72-18	18"W Fits 72"L Unit 45.72cm x 182.88 cm	30	13.6
HDLS96-18	18"W Fits 96"L Unit 45.72cm x 243.84 cm	40	18.1



PART NO.	DESCRIPTION	Wgt. (lbs)	Wgt. (kgs)
TIS1248	12"W x 48"L x 15"H 30.48cm x 121.92cm x 38.10cm	34	15.45
TIS1260	12"W x 60"L x 15"H 30.48cm x 152.40cm x 38.10cm	40½	18.41
TIS1272	12"W x 72"L x 15"H 30.48cm x 182.88cm x 38.10cm	47	21.36
TIS1296	12"W x 96"L x 15"H 30.48cm x 243.84cm x 38.10cm	60	27.27

PART NO.	DESCRIPTION	Wgt. (lbs)	Wgt. (kgs)
TIS1848	18"W x 48"L x 15"H 45.72cm x 121.92cm x 38.10cm	38	17.27
TIS1860	18"W x 60"L x 15"H 45.72cm x 152.40cm x 38.10cm	44½	20.23
TIS1872	18"W x 72"L x 15"H 45.72cm x 182.88cm x 38.10cm	51	23.18
TIS1896	18"W x 96"L x 15"H 45.72cm x 243.84cm x 38.10cm	64	29.09

## FULL WIDTH LOWER SHELF

Steel painted to match frame, mounts at lower level.

Actual Depth 17.25"		Wgt. (lbs)	Wgt. (kgs)
PART NO.	DESCRIPTION		
FWLS48-24	24"W Fits 48"L Unit 60.96cm x 121.92 cm	25	11.3
FWLS60-24	24"W Fits 60"L Unit 60.96cm x 152.40 cm	31¼	14.2
FWLS72-24	24"W Fits 72"L Unit 60.96cm x 182.88 cm	37½	17
FWLS96-24	24"W Fits 96"L Unit 60.96cm x 243.84 cm	50	22.7

Actual Depth 23.25"		Wgt. (lbs)	Wgt. (kgs)
PART NO.	DESCRIPTION		
FWLS48-30	30"W Fits 48"L Unit 76.20cm x 121.92 cm	30	13.6
FWLS60-30	30"W Fits 60"L Unit 76.20cm x 152.40 cm	37½	17
FWLS72-30	30"W Fits 72"L Unit 76.20cm x 182.88 cm	45	20.4
FWLS96-30	30"W Fits 96"L Unit 76.20cm x 243.84 cm	60	27.2

Actual Depth 29.25"		Wgt. (lbs)	Wgt. (kgs)
PART NO.	DESCRIPTION		
FWLS48-36	36"W Fits 48"L Unit 91.44cm x 121.92 cm	35	15.9
FWLS60-36	36"W Fits 60"L Unit 91.44cm x 152.40 cm	43¾	19.8
FWLS72-36	36"W Fits 72"L Unit 91.44cm x 182.88 cm	52½	23.8
FWLS96-36	36"W Fits 96"L Unit 91.44cm x 243.84 cm	70	31.8



## TUBULAR INSTRUMENT SHELF

T mold plastic laminate shelf supported with heavy duty tubular steel frame.

Other heights available at an additional charge



## CORKBOARD TACK BOARD

Tack board corkboard front with white plastic laminate rear. T mold edges for clean finish look includes supports. Mounts to uprights.

PART NO.	DESCRIPTION	Wgt. (lbs)	Wgt. (cap)
TB24	24" x 12"	5.75	2.6
TB30	30" x 12"	7.25	3.3
TB36	36" x 12"	8	3.6
TB48	48" x 12"	9.25	4.2
TB60	60" x 12"	11	5
TB72	72" x 12"	13	5.9
TB96	96" x 12"	17	7.7

## SOLDER SPOOL HOLDER

Fits standard solder rolls. Also mounts onto Bin Holders.

PART NO.	DESCRIPTION	Wgt. (lbs)	Wgt. (kgs)
SH-1	Solder Spool Holder	.5	.22

## ARTICULATING BIN HOLDER

17"H x 18"W locks in 2 positions. Bins optional. Extends up to 23.5" from upright. Textured Black panel. Frame of ABH to match work bench frame

PART NO.	DESCRIPTION	Wgt. (lbs)	Wgt. (cap)
ABH-1	Articulating Bin Holder	19	60



PART NO.	DESCRIPTION	Wgt. (lbs)	Wgt. (cap)
DP-1	15"L x 12"W x 12"H	13	65
DP-HK	mounting bracket	1	



## PAD LOCK DRAWER

Drawer with hasp for pad lock. Drawer features louvers for ventilation. Requires one **HK** mounting bracket per workstation. Part# DP-HK

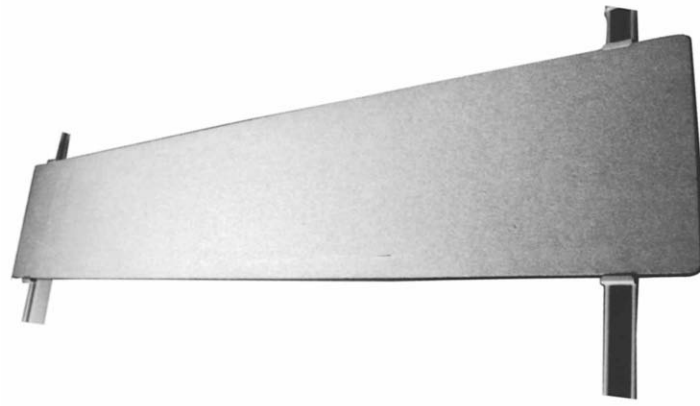
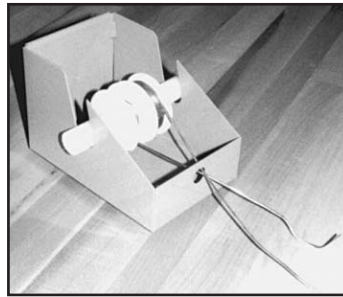

## FREE STANDING FOOTREST

Adjustable for different size operators from 3" to 11".

PART NO.	DESCRIPTION	Wgt. (lbs)	Wgt. (cap)
T-20	Free Standing Footrest 12" x 20"	10	150

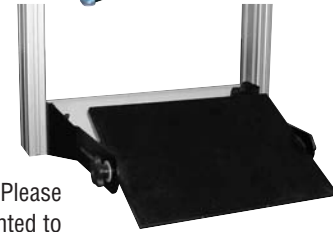

Suspends from bottom of frame Please specify model to be mounted to

Example: AT-20/HD Attached Adjustable Footrest

PART NO.	DESCRIPTION	Wgt. (lbs)	Wgt. (cap)
AT-20	Attached Footrest with 12" x 20" pan	35	75

## ARTICULATING MONITOR ARM

With 14" x 14" platform. Platform rotates 360°. Price includes clip on keyboard tray and mounting bracket. Extends up to 27.5" from upright. Up to 40 lbs. For higher capacity see page 41.

PART NO.	DESCRIPTION	Wgt. (lbs)	Wgt. (cap)
MA-1	Monitor Arm	19	50



## TORQUE ARM / BALANCER AND STAND

Eliminate torque when powered assembly tools are activated!

36" Swing boom pivots on 60" column above worksurface. Provides full coverage for 60" x 30" worksurface.

- Pneumatic tool not included!

PART NO.	DESCRIPTION	Wgt. (lbs)
TQ-1	Torque Arm/Balancer	31



## FSMA FLAT SCREEN MONITOR ARM\*

75mm or 100mm Hole to Hole Mounting.  
FSMA extends up to 25" from the upright

PART NO.	DESCRIPTION	Wgt. (lbs)
FSMA	Flat Screen Monitor Arm	21
FSMAKBT	Adjustable Keyboard Tray	11



\*MONITOR AND KEYBOARD NOT INCLUDED  
AVAILABLE IN TEXTURED BLACK ONLY

ACCESSORIES

## TOOL BALANCER

Balance out assembly tools so they weigh next to nothing!

PART NO.	DESCRIPTION	Wgt. (lbs)
TB-1	For tools weighing up to 1 lb	6
TB-5	For tools weighing up to 5 lbs	6



## 3 DIOPTER INSPECTION LIGHT

Requires Lomb from page 31 to mount to accessory uprights.  
Standard color Black.

PART NO.	DESCRIPTION	Wgt. (lbs)	Wgt. (cap)
MAG1	3 Diopter/45" Arm	9	N/A



## DOCUMENT HOLDER

Requires Lomb from page 31 to mount to accessory uprights.

PART NO.	DESCRIPTION	Wgt. (lbs)	Wgt. (cap)
DH-1	10" x 12" / 33" Reach	10	2

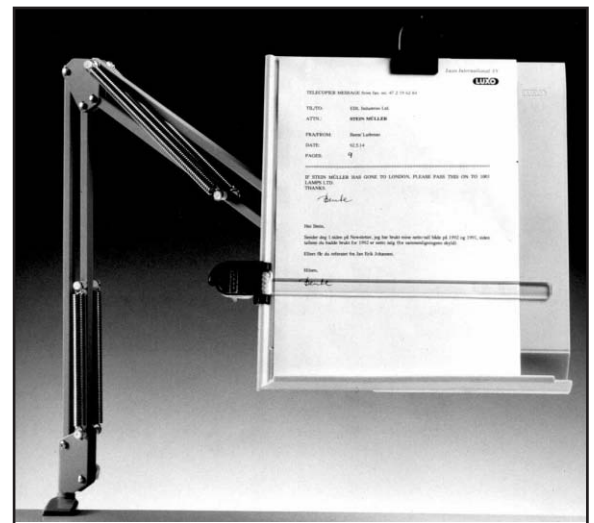

## TOOL HOLDER

Sits on worksurface or hangs on bin holder.

PART NO.	DESCRIPTION	Wgt. (lbs)	Wgt. (cap)
TH-1	Tool Holder	.5	.22



## UNDER SHELF PULL OUT KEYBOARD TRAY

Stores your keyboard under the shelf when not in use. Allows for more room on your work surface.

PART NO.	DESCRIPTION	Wgt. (lbs)
UPKT1248	12"D mounts to CSPL1248	12
UPKT1260	12"D mounts to CSPL1260	20
UPKT1272	12"D mounts to CSPL1272	32



## PIVOTING TOOL HOLDER

Mounts to our vertical uprights. Allows tool to be pivoted over work surface. Available in 18" and 24" lengths.

PART NO.	DESCRIPTION	Wgt. (lbs)
PTH18	Extends 18" from upright	4.5
PTH24	Extends 24" from upright	5.5

## BUILT IN LAZY SUSAN

Fits flush mount in any basic workstation. 18" diameter.

PART NO.	DESCRIPTION	Wgt. (lbs)	Wgt. (kgs)
LZ-1	Flush Mount Lazy Susan 18" Diameter	21	200

Must be ordered with initial purchase.

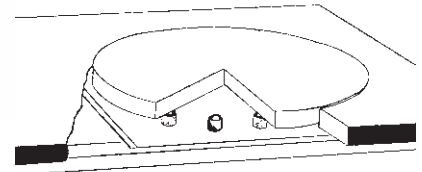

## CONVEYOR PALLETS

Custom sizes available upon request.  
For Standard Laminate add **PL** to Part #.  
For **ESD** Laminate add **ESD** to Part #.

PART NO.	DESCRIPTION	Wgt. (lbs)	Wgt. (cap)	Plastic Laminate	ESD Laminate
CP1824	18" x 24" x 3/4"	9	250	CP1824PL	CP1824ESD
CP2424	24" x 24" x 3/4"	12	250	CP2424PL	CP2424ESD
CP1836	18" x 36" x 3/4"	13.5	250	CP1836PL	CP1836ESD

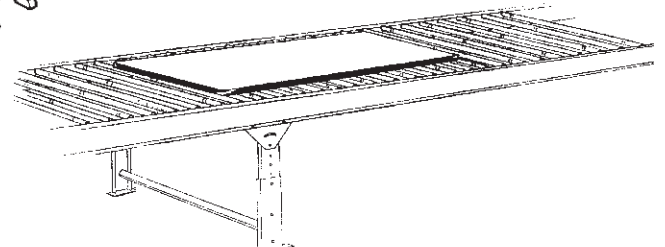
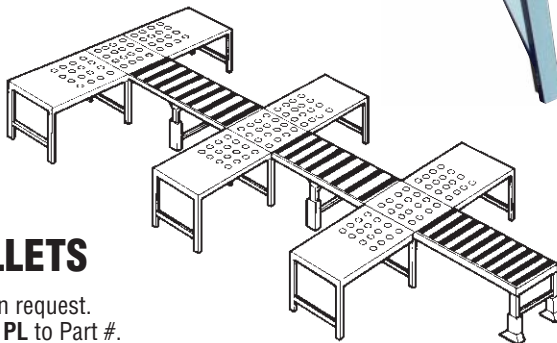

# MAKE YOUR WORKSTATION MOBILE... OR STATIONARY

## CASTERS TWO SWIVEL/TWO BRAKE

To mobilize workstations soft tread Polyurethane caster. 3" diameter wheel.

PART NO.	DESCRIPTION	Wgt. (lbs)	Wgt. (cap)
<b>C-4</b>	Stem Casters (set of 4) All swivel 2 with brake	4	400
<b>POC-4</b>	Stem Casters (set of 4) with polypropelene wheels All swivel 2 with brakes	4	400

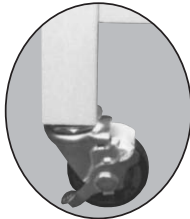

C-4

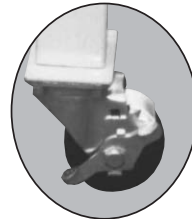

PC-4 Swivel

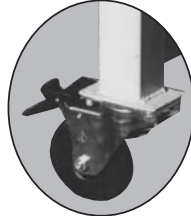

Total Lock

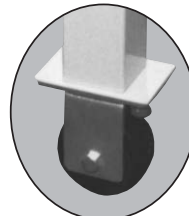

PC-4 Rigid

PART NO.	DESCRIPTION	Wgt. (lbs)	Wgt. (cap)
<b>PC-4</b>	Plate Casters 2 swivel with brake 2 rigid (set of 4)	5	400
<b>TLC-4</b>	Total Lock Casters a set of 4 4" casters locks both wheel and swivel. Plate style caster	6	400
<b>ELH POC-4</b>	For ELH Series only All Swivel	4	400

All Priced per set of four.

All casters feature Polyurethane wheels

## CASTER APPLICATIONS For Various Models

- C-4** Four leg workstations without leg extenders (can be added at any time) all four swivel. Models HD, TSHD, TW, PB, P, BT, GRBT. **Adds 3.25" to Height.**
- PC-4** Requires caster plates welded to station. Cantilever models, stations with HDLE-6, flexlines, 2 Swivel, 2 Rigid with brakes. **Adds 3.25" to Height.**
- TLC-4** Requires caster plates welded to station. All four have locks that locks both swivel and roll. Suggested uses EL, MVSII, and Modular cabinets. **Adds 4.25" to Height.**
- ELH POC-4** For ELH Series, All swivel Additional charges apply.

**PC-4, TLC-4 Must order at time of workstation purchase or they will require a mounting bracket that is available at an additional cost**  
**For non-stock benches, please specify the overall bench height**

## LAG PLATES

Affix your work bench to the floor



PART NO.	DESCRIPTION	Wgt. (lbs)	Wgt. (cap)
<b>LP</b>	Lag Plates (set of 4)	2	1000

ACCESSORIES



**CALL** — For E.S.D. and/or many other caster options



## DUAL AXIS TOOL SUSPENSION FRAME

Trolleys on this tool suspension frame travel on both axis left to right and forward to rear. Frame extends 30" from upright. Price includes one tool trolley. Shown with UR72.

(Unit shown with torque arm priced on next graph.)

PART NO.	DESCRIPTION	Wgt. (lbs)
<b>DATSF48</b>	30" Deep x 48" Long	12
<b>DATSF60</b>	30" Deep x 60" Long	15
<b>DATSF72</b>	30" Deep x 72" Long	18
<b>DATSF96</b>	30" Deep x 96" Long	25

## TORQUE ARM

Torque Arm and Balancer to mount onto DATSF as shown. (DATSF sold separately.)

PART NO.	DESCRIPTION	Wgt. (lbs)
<b>TQ-2</b>	Torque Arm and Balancer for DATSF. Fits all length stations	5

**Distributed By: Custom Equipment Company**  
**866-333-0728 919-847-5765 fax**



## STEEL PEG BOARD

Steel Peg Boards painted to match frame.  
Mounts to Pro-Line upright system.



## HEAVY DUTY MONITOR ARM

Heavy Duty Monitor Arms feature a 14" x 14" platform.  
Used for monitors 40 lbs to 80 lbs.

PART NO.	DESCRIPTION	Wgt. (lbs)
<b>HDMA-2</b>	Heavy Duty Monitor Arm	24

PART NO.	DESCRIPTION	Wgt. (lbs)
<b>SPB2448</b>	24" High x 48" Long	8
<b>SPB2460</b>	24" High x 60" Long	10
<b>SPB2472</b>	24" High x 72" Long	12
<b>SPB2496</b>	24" High x 96" Long	16



## WIRE MANAGEMENT SYSTEM

Shown in photograph mounted vertically to our upright system. This flexible system can also be mounted horizontally to our upright system. Available in both 1.5" sq. and 2" sq. (Black) Lead free PVC. Priced in 6' long sections. We will cut to fit application. Example: For two pieces 36" long you need one 72" long piece, etc. (Please specify at time of order.)

PART NO.	DESCRIPTION	Wgt. (lbs)
<b>WMS1.5</b>	1.5" x 1.5" x 72" wire trough	3
<b>WMS2</b>	2" x 2" x 72" wire trough	4



## WIRE MANAGEMENT GROMMET

Mounts into work surface. Location varies between models.

PART NO.	DESCRIPTION	Wgt. (lbs)
<b>WMG</b>	Wire Management Grommet	0.25

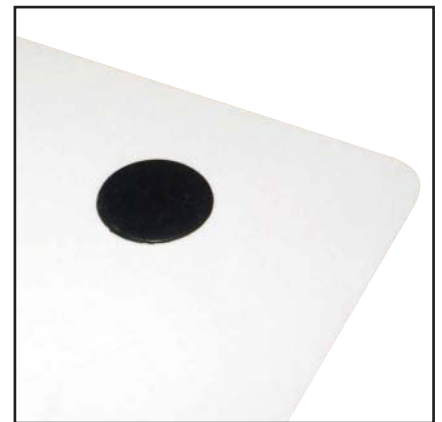

## SNAP-IN SLOT DESIGN and NON-SLIP COVER TYPE G

Material: PVC (Lead-Free)

- Restricted slot design
- Push duct and cover mating design
- Greater wire capacity
- No-slip cover

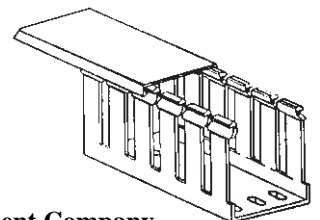

41 Distributed By: Custom Equipment Company  
866-333-0728 919-847-5765 fax

# EUROPEAN ELECTRICAL SUPPLIES

## (250 VAC from 13 AMP to 16 AMP)

Various sockets and cable plugs to meet different country requirements.

PART NO.	DESCRIPTION	Wgt. (lbs)
EE525016A	5 outlets 250vac 16 amp 566.0cm x 51.6cm cord 2.5m continental Europe France/Belguim	1.18
EE525013D	4 outlets 250vac 13 amp 317.0cm x 68.0cm cord 2.5m United Kingdom/Ireland	0.69

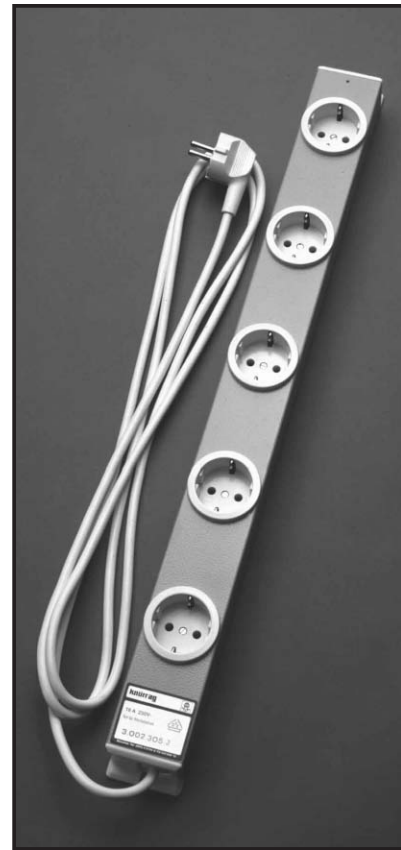
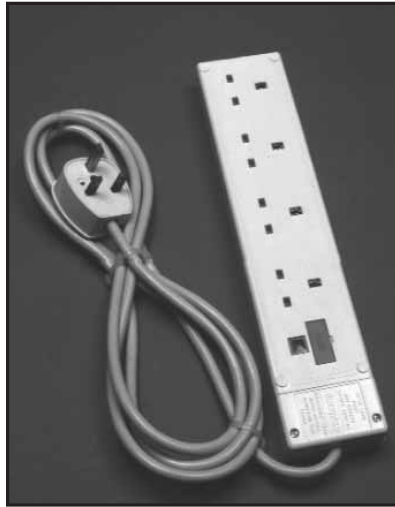

ACCESSORIES

## RETROFIT KIT

Pro-Line's retrofit kits are designed to turn a non-modular bench into a modular workstation. Simply set your legs to the same centers as Pro-Lines centers and you can mount any of our over worksurface accessories. Following is a guide on the outside dimensions of our accessories.

- For a 48"L station 42.5"
- For a 60"L station 54.5"
- For a 72"L station 66.5"
- For a 96"L station 87.5"

PART NO.	DESCRIPTION	Wgt. (lbs)
RK30	Retrofit Kit for a 30" deep worksurface	32
RK36	Retrofit Kit for a 36" deep worksurface	33



## E.S.D. GROUND KITS

PART NO.	DESCRIPTION	Wgt. (lbs)	Wgt. (kgs)
SGK-1	Standard Ground Kit	¼	.1
SGK-J2	Standard Ground Kit w/Banana Plug Jacks	½	.2
FGK-1	Flush Mount Ground Kit w/Jacks	½	.2
SGS-4	Standard Ground Wrist Strap 6' Cord	¼	.1

## WRIST STRAP



Distributed By: Custom Equipment Company  
866-333-0728 919-847-5765 fax

## CHATTER/PRIVACY SHIELDS

These shields are designed to mount to the back of our Heavy Duty Uprights. Shields are ideal to close off workstations from high traffic areas. Shields are available in both painted steel and plastic laminate. **To mount to our standard uprights drilling is required.**



ACCESSORIES

## GUARD RAIL

3" High painted steel guardrails meet in rear corners of work surface. Keeps small items from rolling off surface. Sold in set of one rear guard and two side guards. Mounts to top of work surface.



PART NO.	DESCRIPTION	WGT. (LBS)
<b>CPS48PL</b>	Chatter Shield for 48"L station Plastic Laminate 48" x 36"	35
<b>CPS60PL</b>	Chatter Shield for 60"L station. Plastic Laminate 60" x 36"	44
<b>CPS72PL</b>	Chatter Shield for 72"L station. Plastic Laminate 72" x 36"	53
<b>CPS48ST</b>	Chatter Shield for 48"L station. Painted Steel 48" x 36"	27
<b>CPS60ST</b>	Chatter Shield for 60"L station. Painted Steel 60" x 36"	44
<b>CPS72ST</b>	Chatter Shield for 72"L station. Painted Steel 72" x 36"	53

PART NO.	DESCRIPTION	WGT. (LBS)
<b>GR4830</b>	Guard Rail for 48" x 30" station	6
<b>GR4836</b>	Guard Rail for 48" x 36" station	8
<b>GR6030</b>	Guard Rail for 60" x 30" station	10
<b>GR6036</b>	Guard Rail for 60" x 36" station	12
<b>GR7230</b>	Guard Rail for 72" x 30" station	12
<b>GR7236</b>	Guard Rail for 72" x 36" station	14
<b>GR9630</b>	Guard Rail for 96" x 30" station	18
<b>GR9636</b>	Guard Rail for 96" x 36" station	20