



WORK CENTER

The Rousseau work center system offers a multitude of possible layouts, thanks to its numerous accessories which allow you to create a work center that responds to your exact needs.

Whether you are installing a workbench for a production or assembly line, or a custom layout for your machine tool workshop, our line of products offers you an impressive selection of accessories that are sure to meet and surpass your expectations. Whether you are looking for a basic workbench with two legs and a top, or a specialized table, stationary or mobile, you will find a solution for each and every application. From shipping and receiving, to your foreman's office, the quality and variety of our product will more than satisfy you.

Moreover, the Rousseau multi-purpose stand presents an immense advantage by being so easy to reconfigure, without tools. It can be changed according to your evolving needs by simply adding accessories.

Rousseau offers you several work surface dimensions for each of the surfaces offered: painted steel, stainless steel, laminated wood, laminated Acrylic/PVC, laminated and dissipative plastic tops. Rousseau, the one-stop solution to simplify your life!



LC3011C

Distributed by:
Custom Equipment Company
sales@customMhs.com

The Rousseau Advantages

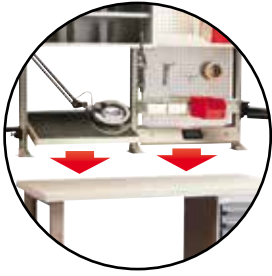

Rousseau will meet even your most specific workbench need, from top to bottom.



Re-configuring your workbench is easy and can be done without tools. This means your system will evolve with you and your needs.



Our impressive array of standard accessories allows you to build a custom bench.

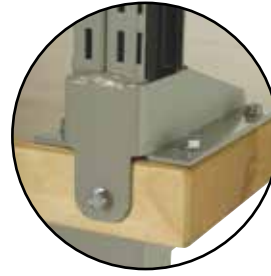

The WM structure can be installed on most industrial workbenches on the market. The six fixing zones mean limited interference and endless possibilities.

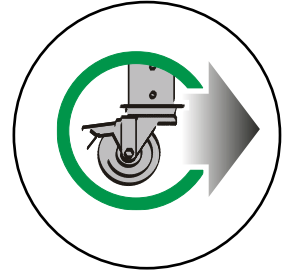

Many of our workbenches can be made mobile in order to better meet your needs.

General Dimensions

Components and accessories are divided into 3 groups and correspond to the principle workstation zones.

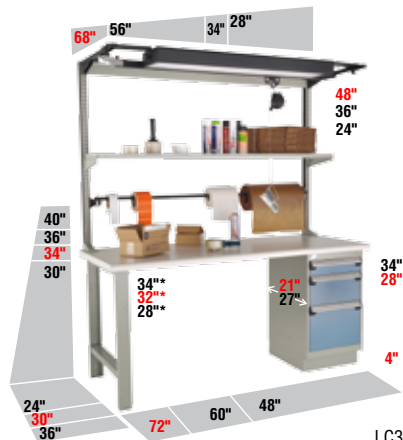

LC3010C

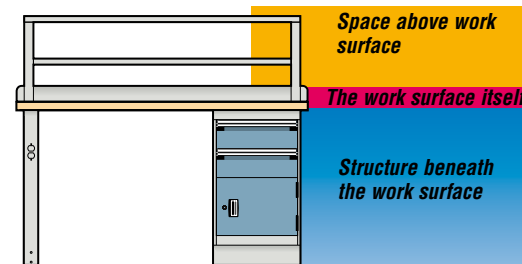

NOTE *Extensions offered for other heights

SEE PAGE 108

Index	Page(s)
Work Center	96 - 97
Proposals	98 - 105
Components	
- work surface	106 - 107
- structure under the work surface	108 - 119
- structure above the work surface	120 - 132
- specialized structure for technician	133 - 135
- 5S storage	136 - 137
Multi-Purpose Stand	138
Proposals	139 - 140
Components	141

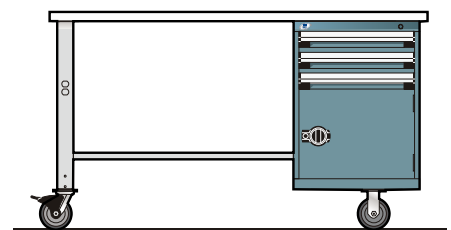
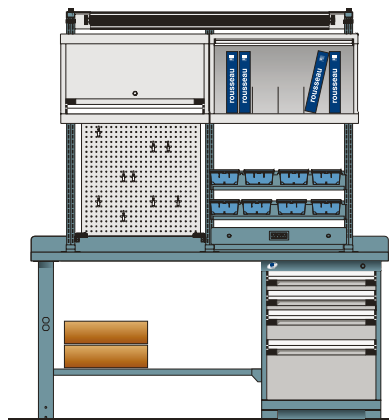
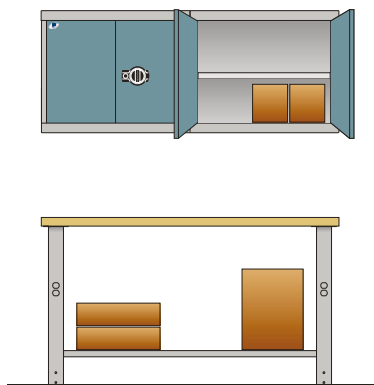

Workstations – Tables and Multi-Purpose Frames

Basic Workstation

WSC0133

Better organization with the help of Rousseau accessories.



WSC0133

1 WM single unit frame	WM11-2848
2 tilttable shelves	WM20-2812
2 plastic bin rails	WM28-2801
1 vertical adaptor for electrical and air outlets	WM41-01
1 power outlet strip	70000505
6 partial dividers	SH52-1206
5 plastic bins	RG20-040303
2 open legs	WS20-2732
1 stringer	WS22-6005
1 painted steel top	WS10-6030

Product #	W x D x H
WSC0133	60" x 30" x 80"

Packaging Station

WSM0006

All the right accessories for a packaging station, with a spool support under the table.



WSM0006

2 multi-purpose uprights	WM10-48
2 steel shelves	WS50-6012
2 structural shelf supports	WM27-1201
6 sliding dividers	WS87-1210
1 vertical adaptor for electrical and air outlets	WM41-01
1 power strip	70000505
1 document holder with arm	WM70-01
2 open legs	WS20-2732
1 stringer	WS22-6005
1 laminated wood top	WS14-6030A

1 paper and cardboard spool support	WS86-60
2 leg crossbars	WS24-27

Product #	W x D x H
WSM0006	60" x 30" x 80"

SOLD SEPARATELY

Packaging shear cutter WSM87-01

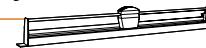

SEE PAGE 110

End-of-Aisle Workstation

WSM0017

Perfect for consulting information close to stored materials.

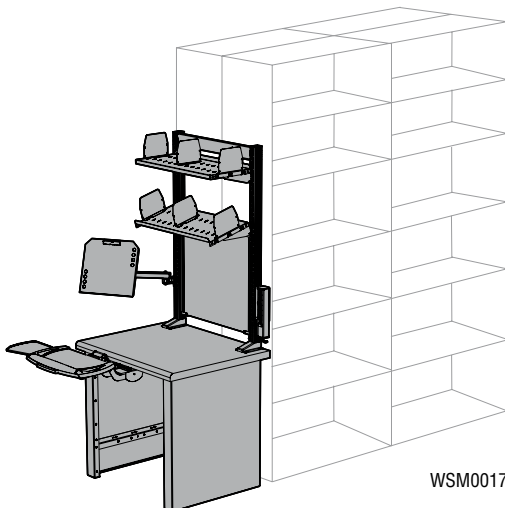

WSM0017

2 closed legs	WS25-2732
1 laminated wood top	WS14-3630A
1 WS90-01 sliding keyboard tray or WS90-02 adjustable keyboard tray (except on WSM0018 model without keyboard tray)	
1 single unit frame	WM11-2848
2 tilttable shelves	WM20-2812
6 partial dividers	SH52-1206
1 power strip	7000505
1 vertical adaptor for electrical and outlets	WM41-01
1 document holder with arm	WM70-01
1 tackboard / marker panel	WM54-2424
1 panel bracket kit	WM50-01

Product #	Type of Keyboard Tray	W x D x H
WSM0016	WS90-01 sliding tray	36" x 30" x 80"
WSM0017	WS90-02 adjustable tray	36" x 30" x 80"
WSM0018	Model without tray	36" x 30" x 80"

SOLD SEPARATELY

Footrest WSM27-2012

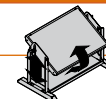

SEE PAGE 108

IMPORTANT

An ergonomic chair and footrest are recommended for this type of workstation.

Distributed by:
Custom Equipment Company
sales@customMhs.com

Electronic Workstation

LC3002C



LC3002C



Protects sensitive electronic equipment.

1 WM unit frame	WM11-5648
2 tiltable shelves	WM20-2812
2 plastic bin rails	WM28-2801
1 power outlet channel	WM40-281001
1 monitor tray with arm	WM62-01A
1 tiltable pan	WM22-2820
1 storage cabinet with door	WM75-281516L3
1 pair of cantilever overhead supports	WM18-26
1 overhead workstation light	WM45-48T8-56
7 partial dividers (4 inside storage cabinet)	SH52-1206

5 plastic bins	RG20-040303
1 fluorescent work lamp with magnifier	70000635
1 adaptor for lamp or light-duty arm	WM68-01
1 open leg	WS20-2732
1 compact cabinet «L» with 4" base	L3ABD-2808C
1 pair of cabinet attachment bars	RA70-21
1 dissipative top	WS17-6030A
1 grounding block	70000350
1 ground wrist strap	70000320

Product #	W x D x H
LC3002C	60" x 30" x 80"

Quality Control Workstation

LC3003C



LC3003C



Our proposal to enhance quality control and inspection tasks.

1 single WM unit frame	WM11-2848
1 tiltable shelf	WM20-2812
1 overhead workstation light	WM45-48T8-28
1 pair of cantilever overhead supports	WM18-26
1 power outlet channel	WM40-281001
1 LCD monitor and keyboard holder	WM65-02B
1 tackboard / marker panel	WM54-2424
1 panel bracket kit	WM50-01

3 partial dividers	SH52-1206
1 open leg	WS20-2732
1 compact cabinet «L» with 4" base	L3ABD-2808C
1 pair of cabinet attachment bars	RA70-21
1 plastic laminate top	WS16-6030A

Product #	W x D x H
LC3003C	60" x 30" x 80"

Assembly Workstation

LC3001



LC3001

Designed to promote efficient assembly work.

1 double WM unit frame	WM11-5648
2 plastic bin rails	WM28-2801
1 vertical adaptor for electrical and air outlets	WM41-01
1 power outlet strip	70000505
1 document holder with arm	WM70-01
1 perforated panel	WM53-2436
2 panel bracket kits	WM50-01
1 tackboard / marker panel	WM54-2424
1 overhead workstation light	WM45-48T8-56
1 tool rail	WM47-6001
1 pair of cantilever overhead supports	WM18-26
1 balancer trolley	WM48-01

1 tool balancer	WM49-01
5 plastic bins	RG20-040303
1 pack of 10 double back single hooks	WM98-03
2 open legs	WS20-2732
1 drawer unit	LD75-182109
2 compact drawers of 3"	LF31-182103
1 plastic laminate top	WS16-6030A
1 stringer	WS22-6005

Product #	W x D x H
LC3001	60" x 30" x 80"

Distributed by:
Custom Equipment Company
sales@customMhs.com

Basic Workstation with "R" Heavy-Duty Cabinet

R5WH5-2005



R5WH5-2005

Both bulky and high density storage in one workstation.

1 heavy-duty cabinet with partitioning	R5ACG-3013
1 open leg	WS20-2732
1 laminated wood top	WS14-6030A
2 storage cabinets with double integrated doors	R5MDA-3003
2 WM brackets for storage cabinet	RD08-28
1 double WM unit frame	WM11-5648

Product #	W x D x H
R5WH5-2005	60" x 30" x 80"

Assembly Workstation with "R" Heavy-Duty Cabinet

R5WH5-2003



R5WH5-2003

Access your parts and tools faster.

1 heavy-duty cabinet with partitioning	R5ACG-3013
1 laminated wood top	WS14-6030A
1 open leg	WS20-2732
1 double WM unit frame	WM11-5648
1 tiltable shelf	WM20-2812
2 partial dividers	SH52-1206
1 vertical adaptor for electrical and air outlets	WM41-01
1 power outlet strip	70000505
1 steel shelf	WS50-6012
1 pair of structural shelf supports	WM27-1201
1 privacy panel	WM52-2436
1 panel bracket kit	WM50-01
1 louvered panel	WM55-2836
2 plastic bins	RG20-060603
5 plastic bins	RG20-060602

Product #	W x D x H
R5WH5-2003	60" x 30" x 80"

Maintenance Workstation with "R" Heavy-Duty Cabinets

R5WL5-2003



R5WL5-2003



Designed to centralize all of the materials needed for your activities.

1 heavy-duty cabinet with partitioning	R5ACG-3013	1 tool support	WM30-01
1 heavy-duty cabinet with partitioning	R5ACG-3015	4 plastic bins	RG20-060603
1 laminated wood top	WS14-7230A	1 power outlet channel	WM40-281001
2 steel shelves	WS50-2412	1 tiltable pan	WM22-2820
2 adaptors for WS50 shelf	RC15-24	2 tiltable shelves	WM20-2812
1 double WM unit frame	WM11-5648	4 partial dividers	SH52-1206
1 pair of cantilever overhead supports	WM18-26	2 storage cabinets with door	WM75-281516L3
1 overhead workstation light	WM45-48T8-56	1 document holder with arm	WM70-01
1 tool rail	WM47-6001	1 LCD monitor and keyboard holder	WM65-02B
1 balancer trolley	WM48-01		
1 tool balancer	WM49-01		
2 plastic bin rails	WM28-2801		

Product #	W x D x H
R5WL5-2003	72" x 30" x 80"

For More Information: 866-333-0728
 Custom Equipment Company
 Sales: sales@customMhs.com
 www.customMhs.com

Work Surfaces

WORK CENTER

Painted Steel Top

WS10



Top for industrial, maintenance, repair or assembly applications;
 Thickness : 1 3/4";
 2 steel crossbars for attaching legs;
 3 wood crossbars (2" x 4") for attaching cabinets and other accessories;
 May be reinforced or soundproofed with a WS75 wood filler;
 Excellent impact resistance;
 Powder paint.

Stainless Steel Top

WS12



Top for industrial, maintenance, repair or assembly applications or when solvents, oils or other chemical products are being used;
 Thickness : 1 3/4". 12 gauge steel;
 Brushed finish #4, attractive appearance;
 2 steel crossbars for attaching legs;
 3 wood crossbars (2" x 4") for attaching cabinets and other accessories;
 May be reinforced or soundproofed by adding a WS75 wood filler;
 Excellent corrosion resistance;
 Excellent chemical resistance (can be in prolonged contact with a substance);
 Note : The RC35 top is also compatible with the fixed workstations (not recommended for mobile applications), see page 11.

Laminated Wood Top

WS14



Top for general industrial applications;
 Thickness : 1 3/4";
 Made with varnished hardwood slats;
 90° radius front edge for more comfort;
 Good impact resistance;
 Attractive appearance.

Resistant Acrylic / PVC Plastic Laminated Top

WS08



Ideal for assembly stations or for applications using solvents, oils or other chemical products;
 Thickness : 1 1/2";
 Color : Gray;
 Core made of particle board;
 Finish : sheet of gray polymer;
 Deluxe quality laminated top;
 Excellent chemical product resistance (can be in prolonged contact with a substance);
 Superior abrasion resistance compared to standard laminated top;
 Superior impact resistance compared to standard laminated top;
 Attractive appearance.

Plastic Laminated Top

WS16



Top for general applications. Ideal for assembly, quality control and packaging applications;
 Thickness : 1 1/2";
 Color : White;
 Attractive appearance;
 Easy to clean;
 90° radius front edge for more comfort.

Dissipative Top

WS17



Top for electronics applications. Ideal for assembly or electronics inspection stations;
 Thickness : 1 1/2";
 Color : White;
 Attractive appearance;
 Easy to clean;
 90° radius front for more comfort;
 Dissipates electric charges that can damage electronic components;
 Resistance point to point and point to ground between 10⁹ and 10⁹ Ω.

NOTE Please refer to W54 tech sheet for capacity according to configuration. Available on Multi Tool CD.

NOTE The 21" deep cabinets are compatible with the 24" WS10/12 tops.
 The 21" deep cabinets are not compatible with the 30" and 36" WS10/12 tops.
 The 27" deep cabinets are compatible with the 30" and 36" WS10/12 tops.

Dimensions		Type of Top					
W	D	Acrylic/PVC Plastic Laminated	Painted Steel	Stainless Steel	Laminated Wood	Plastic Laminated	Dissipative
36"	24"				WS14-3624A	WS16-3624A*	
	30"				WS14-3630A	WS16-3630A*	
48"	24"	WS08-4824A*	WS10-4824	WS12-4824 *	WS14-4824A	WS16-4824A*	WS17-4824A*
	30"	WS08-4830A*	WS10-4830	WS12-4830 *	WS14-4830A	WS16-4830A	WS17-4830A*
	36"	WS08-4836A*	WS10-4836	WS12-4836 *	WS14-4836A*	WS16-4836A*	WS17-4836A*
60"	24"	WS08-6024A*	WS10-6024	WS12-6024 *	WS14-6024A	WS16-6024A	WS17-6024A*
	30"	WS08-6030A	WS10-6030	WS12-6030 *	WS14-6030A	WS16-6030A	WS17-6030A
	36"	WS08-6036A*	WS10-6036	WS12-6036 *	WS14-6036A	WS16-6036A	WS17-6036A*
72"	24"	WS08-7224A	WS10-7224	WS12-7224 *	WS14-7224A	WS16-7224A	WS17-7224A*
	30"	WS08-7230A	WS10-7230	WS12-7230 *	WS14-7230A	WS16-7230A	WS17-7230A
	36"	WS08-7236A	WS10-7236	WS12-7236 *	WS14-7236A	WS16-7236A	WS17-7236A

NOTE *Please check with your customer service representative for lead time.