



## WORK CENTER

The Rousseau work center system offers a multitude of possible layouts, thanks to its numerous accessories which allow you to create a work center that responds to your exact needs.

Whether you are installing a workbench for a production or assembly line, or a custom layout for your machine tool workshop, our line of products offers you an impressive selection of accessories that are sure to meet and surpass your expectations. Whether you are looking for a basic workbench with two legs and a top, or a specialized table, stationary or mobile, you will find a solution for each and every application. From shipping and receiving, to your foreman's office, the quality and variety of our product will more than satisfy you.

Moreover, the Rousseau multi-purpose stand presents an immense advantage by being so easy to reconfigure, without tools. It can be changed according to your evolving needs by simply adding accessories.

Rousseau offers you several work surface dimensions for each of the surfaces offered: painted steel, stainless steel, laminated wood, laminated Acrylic/PVC, laminated and dissipative plastic tops. Rousseau, the one-stop solution to simplify your life!



LC3011C

**Distributed by:**  
**Custom Equipment Company**  
[sales@customMhs.com](mailto:sales@customMhs.com)

## The Rousseau Advantages

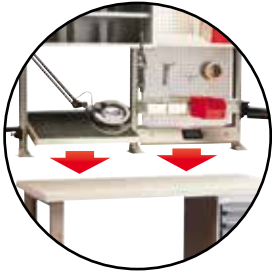

Rousseau will meet even your most specific workbench need, from top to bottom.



Re-configuring your workbench is easy and can be done without tools. This means your system will evolve with you and your needs.



Our impressive array of standard accessories allows you to build a custom bench.

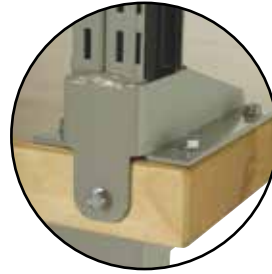

The WM structure can be installed on most industrial workbenches on the market. The six fixing zones mean limited interference and endless possibilities.

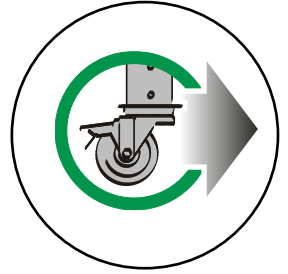

Many of our workbenches can be made mobile in order to better meet your needs.

## General Dimensions

Components and accessories are divided into 3 groups and correspond to the principle workstation zones.

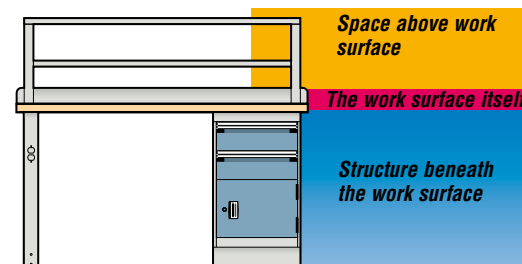

Index	Page(s)
<b>Work Center</b>	96 - 97
Proposals	98 - 105
Components	
- work surface	106 - 107
- structure under the work surface	108 - 119
- structure above the work surface	120 - 132
- specialized structure for technician	133 - 135
- 5S storage	136 - 137
<b>Multi-Purpose Stand</b>	138
Proposals	139 - 140
Components	141

NOTE \*Extensions offered for other heights

SEE PAGE 108

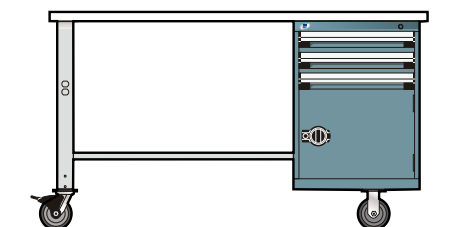
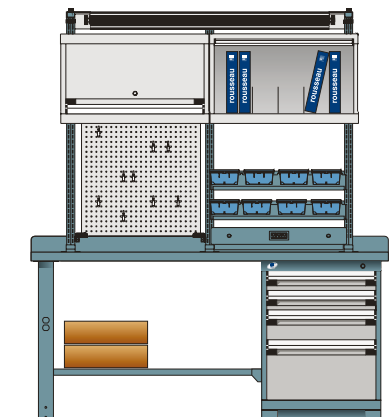
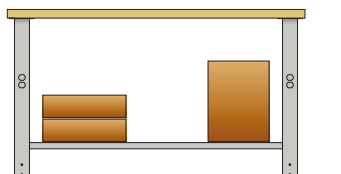
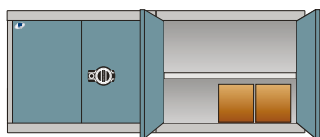

# Proposals

WORK CENTER

## Workbench with Compact Cabinet

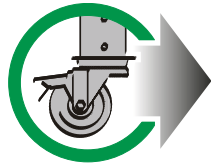

This table can be made mobile.

27" deep cabinets are recommended for mobile workstations or workstations with multi-purpose frames.

Dimensions			Type of Top			
W	D	H	Painted steel	Lam. wood	Plastic lam.	Acrylic/PVC
60"	30"	34"	L_1101C	<b>L_2101C</b>	L_3101C	L_9101C
72"	30"	34"	L_1102C	L_2102C	L_3102C	L_9102C
72"	36"	34"	LH1103C	LH2103C	LH3103C	LH9103C

**NOTE** To order, complete part number according to the following:  
**G** for a stationary bench with 21" deep cabinet (for 30" D benches only);  
**H** for a stationary bench with 27" deep cabinet (for 30" D and 36" D benches only);  
**J** for a mobile bench.

- 1 top of your choice;
  - 1-27" D x 32" H leg;
  - 1 "L" compact cabinet with 4" base;
  - 1 pair of cabinet attachment bars.
- Mobile model (total height 35") includes the following additional accessories:
- 1 base for casters for compact cabinet;
  - 1 pair of caster adaptors for leg;
  - 1 pair of 4" rigid casters;
  - 1 pair of 4" swivel casters with total-lock brake;
  - 1 footrest.
- Note : Cabinet base not included with mobile model.

## Workbench with Two Compact Cabinets



27" deep cabinets are recommended for mobile workstations or workstations with multi-purpose frames.

Dimensions			Type of Top			
W	D	H	Painted steel	Lam. wood	Plastic lam.	Acrylic/PVC
60"	30"	34"	L_1201C	<b>L_2201C</b>	L_3201C	L_9201C
72"	30"	34"	L_1202C	L_2202C	L_3202C	L_9202C
72"	36"	34"	LH1203C	LH2203C	LH3203C	LH9203C

**NOTE** To order, complete part number according to the following:  
**G** for a stationary bench with 21" deep cabinet (for 30" D benches only);  
**H** for a stationary bench with 27" deep cabinet (for 30" D and 36" D benches only);

**NOTE** These models cannot be used in mobile applications.

- 1 top of your choice;
- 2 "L" compact cabinets with 4" bases;
- 2 pairs of cabinet attachment bars.

## Workbench with Suspended Compact Cabinet



**NOTE** Maximum capacity of 50 lbs per drawer in a suspend cabinet application using RA70.

Dimensions			Type of Top			
W	D	H	Painted steel	Lam. wood	Plastic lam.	Acrylic/PVC
60"	30"	34"	LG1001	<b>LG2001</b>	LG3001	LG9001
72"	30"	34"	LG1002	LG2002	LG3002	LG9002
72"	36"	34"	LG1003	LG2003	LG3003	LG9003

**NOTE** These models cannot be used in mobile applications.

- 1 top of your choice;
- 2-27" D x 32" H legs;
- 1 stringer;
- 1-21" deep "L" compact cabinet;
- 1 pair of cabinet attachment bars.

**Distributed by:**  
**Custom Equipment Company**  
 sales@customMhs.com

For More Information: 866-333-0728

## Desk with Compact Cabinet



LG3107



27" deep cabinets are recommended for workstations with multi-purpose frames.

Dimensions			Type of Top		
W	D	H	Painted steel	Lam. wood	Plastic lam.
60"	30"	30"	LG1107	LG2107	<b>LG3107</b>
72"	30"	30"	LG1108	LG2108	LG3108
72"	36"	30"	LH1109	LH2109	LH3109

- 1 top of your choice;
- 1-27" D x 28" H closed leg;
- 1 "L" compact cabinet of 21" D;
- 1 pair of cabinet attachment bars.

**NOTE** These models cannot be used in mobile applications.

## Workbench with Heavy-Duty Cabinets



R5WH5-2007

- 1 laminated wood top WS14-6030A
- 1-27" D x 32" H leg WS20-2732
- 1 heavy-duty cabinet with partitioning R5ACG-3013

Product #	W x D x H
R5WH5-2007	60" x 30" x 34"

**NOTE** This model cannot be used in mobile applications.



R5WL5-2001

- 1 laminated wood top WS14-7230A
- 1 heavy-duty cabinet with partitioning R5ACG-3013
- 1 heavy-duty cabinet with partitioning R5ACG-3015

Product #	W x D x H
R5WL5-2001	72" x 30" x 34"

**NOTE** This model cannot be used in mobile applications.



R5WH4-2001

- 1 laminated wood top WS14-6027A
- 1 heavy-duty cabinet with partitioning R5ACG-3013
- 1 heavy-duty cabinet with partitioning R5ADG-5827
- 1 side bracket for top RA73-02

Product #	W x D x H
R5WH4-2001	90" x 27" x 60"

**NOTE** This model cannot be used in mobile applications.

Distributed by:  
**Custom Equipment Company**  
 sales@customMhs.com

## Basic Electronic Workbench



WSA4073



Dimensions			Type of Top		
W	D	H	Laminated wood	Plastic laminated	Dissipative*
60"	30"	34"	WSA2073	WSA3073	<b>WSA4073*</b>
72"	30"	34"	WSA2074	WSA3074	WSA4074*
72"	36"	34"	WSA2075	WSA3075	WSA4075*

- |                       |   |
|-----------------------|---|
| 1 top of your choice; | 1 pair of risers with electrical outlets on both sides; |
| 2-27" D x 32" H legs; | 1-12" D shelf, same material as top;                    |
| 1 back stop;          | 1 shelf back.   |
| 1 stringer;           |   |

**NOTE** \* Models with dissipative tops come with:  
1 grounding block;  
1 grounding cord and 1 ground wrist strap.

SEE PAGE 122

## Electronic Workbench with Cabinet



LG4104C



Dimensions			Type of Top		
W	D	H	Laminated wood	Plastic laminated	Dissipative*
60"	30"	34"	LG2104C	LG3104C	<b>LG4104C*</b>
72"	30"	34"	LG2105C	LG3105C	LG4105C*
72"	36"	34"	LH2106C	LH3106C	LH4106C*

- |                                     |   |
|-------------------------------------|---|
| 1 top of your choice;               | 1 pair of risers with electric outlets on both sides; |
| 1-27" D x 32" H leg;                | 1-12" D shelf, same material as top;                  |
| 1 "L" compact cabinet with 4" base; | 1 shelf back;   |
| 1 back stop;                        | 1 pair of cabinet attachment bars.                    |

**NOTE** \* Models with dissipative tops come with:  
1 grounding block;  
1 grounding cord and 1 ground wrist strap.

SEE PAGE 122

## Adjustable Workbench



WSA3050

Dimensions			Type of Top			
W	D	H	Painted steel	Lam. wood	Plastic lam.*	Dissipative**
60"	30"	30" to 42"	WSA1050	WSA2050	<b>WSA3050*</b>	WSA4050**
72"	30"	30" to 42"	WSA1051	WSA2051	WSA3051*	WSA4051**
72"	36"	30" to 42"	WSA1052	WSA2052	WSA3052*	WSA4052**

\* 725 lb capacity.

- |  |                                      |
|--|--------------------------------------|
| 1 top of your choice;                      | 12" vertical adjustment (30" - 42"); |
| 2-27" D x 27" H open legs for lift system; | 1-17" high stringer;                 |
| 1 hydraulic lifting system;                | Compatible with WM accessories;      |
| Anti-skid leveling glides;                 | System capacity: 825 lb.             |

**NOTE** These models cannot be used in mobile applications.

**NOTE** \*\* Models with dissipative tops come with:  
1 grounding block;  
1 grounding cord and 1 ground wrist strap.

SEE PAGE 122

## Wall-Mounted Workbench with Wall Cabinet



R5WH5-2010

Dimensions		Type of Top		
W	D	Painted steel	Laminated wood	Plastic laminated
60"	30"	R5WH5-1010	<b>R5WH5-2010</b>	R5WH5-3010

- |                       |           |                 |
|-----------------------|-----------|-----------------|
| 1 top of your choice; | 1 shelf   | WS50-6012       |
| 2 legs                | WS95-2428 | 2 wall cabinets |
| 2 leg crossbars       | WS96-24   | R5MDA-3003      |

**NOTE** Leg height is 28" and top thickness is 1 3/4".

## Workstations – Tables and Multi-Purpose Frames

### Basic Workstation

WSC0133

Better organization with the help of Rousseau accessories.



WSC0133

1 WM single unit frame	WM11-2848
2 tilttable shelves	WM20-2812
2 plastic bin rails	WM28-2801
1 vertical adaptor for electrical and air outlets	WM41-01
1 power outlet strip	70000505
6 partial dividers	SH52-1206
5 plastic bins	RG20-040303
2 open legs	WS20-2732
1 stringer	WS22-6005
1 painted steel top	WS10-6030

Product #	W x D x H
WSC0133	60" x 30" x 80"

### Packaging Station

WSM0006

All the right accessories for a packaging station, with a spool support under the table.



WSM0006

2 multi-purpose uprights	WM10-48
2 steel shelves	WS50-6012
2 structural shelf supports	WM27-1201
6 sliding dividers	WS87-1210
1 vertical adaptor for electrical and air outlets	WM41-01
1 power strip	70000505
1 document holder with arm	WM70-01
2 open legs	WS20-2732
1 stringer	WS22-6005
1 laminated wood top	WS14-6030A

1 paper and cardboard spool support	WS86-60
2 leg crossbars	WS24-27

Product #	W x D x H
WSM0006	60" x 30" x 80"

**SOLD SEPARATELY**

Packaging shear cutter WSM87-01

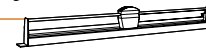

SEE PAGE 110

### End-of-Aisle Workstation

WSM0017

Perfect for consulting information close to stored materials.

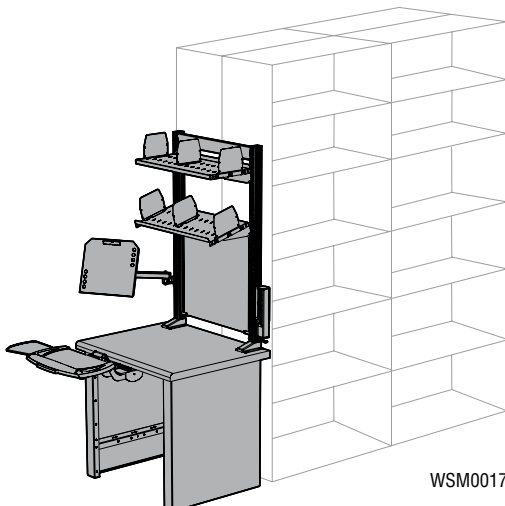

WSM0017

2 closed legs	WS25-2732
1 laminated wood top	WS14-3630A
1 WS90-01 sliding keyboard tray or WS90-02 adjustable keyboard tray (except on WSM0018 model without keyboard tray)	
1 single unit frame	WM11-2848
2 tilttable shelves	WM20-2812
6 partial dividers	SH52-1206
1 power strip	7000505
1 vertical adaptor for electrical and outlets	WM41-01
1 document holder with arm	WM70-01
1 tackboard / marker panel	WM54-2424
1 panel bracket kit	WM50-01

Product #	Type of Keyboard Tray	W x D x H
WSM0016	WS90-01 sliding tray	36" x 30" x 80"
WSM0017	WS90-02 adjustable tray	36" x 30" x 80"
WSM0018	Model without tray	36" x 30" x 80"

**SOLD SEPARATELY**

Footrest WSM27-2012

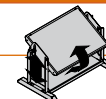

SEE PAGE 108

**IMPORTANT**

An ergonomic chair and footrest are recommended for this type of workstation.

Distributed by:  
Custom Equipment Company  
sales@customMhs.com

## Work Surfaces

WORK CENTER

### Painted Steel Top

**WS10**



Top for industrial, maintenance, repair or assembly applications;  
 Thickness : 1 3/4";  
 2 steel crossbars for attaching legs;  
 3 wood crossbars (2" x 4") for attaching cabinets and other accessories;  
 May be reinforced or soundproofed with a WS75 wood filler;  
 Excellent impact resistance;  
 Powder paint.

### Stainless Steel Top

**WS12**



Top for industrial, maintenance, repair or assembly applications or when solvents, oils or other chemical products are being used;  
 Thickness : 1 3/4". 12 gauge steel;  
 Brushed finish #4, attractive appearance;  
 2 steel crossbars for attaching legs;  
 3 wood crossbars (2" x 4") for attaching cabinets and other accessories;  
 May be reinforced or soundproofed by adding a WS75 wood filler;  
 Excellent corrosion resistance;  
 Excellent chemical resistance (can be in prolonged contact with a substance);  
 Note : The RC35 top is also compatible with the fixed workstations (not recommended for mobile applications), see page 11.

### Laminated Wood Top

**WS14**



Top for general industrial applications;  
 Thickness : 1 3/4";  
 Made with varnished hardwood slats;  
 90° radius front edge for more comfort;  
 Good impact resistance;  
 Attractive appearance.

### Resistant Acrylic / PVC Plastic Laminated Top

**WS08**



Ideal for assembly stations or for applications using solvents, oils or other chemical products;  
 Thickness : 1 1/2";  
 Color : Gray;  
 Core made of particle board;  
 Finish : sheet of gray polymer;  
 Deluxe quality laminated top;  
 Excellent chemical product resistance (can be in prolonged contact with a substance);  
 Superior abrasion resistance compared to standard laminated top;  
 Superior impact resistance compared to standard laminated top;  
 Attractive appearance.

### Plastic Laminated Top

**WS16**



Top for general applications. Ideal for assembly, quality control and packaging applications;  
 Thickness : 1 1/2";  
 Color : White;  
 Attractive appearance;  
 Easy to clean;  
 90° radius front edge for more comfort.

### Dissipative Top

**WS17**



Top for electronics applications. Ideal for assembly or electronics inspection stations;  
 Thickness : 1 1/2";  
 Color : White;  
 Attractive appearance;  
 Easy to clean;  
 90° radius front for more comfort;  
 Dissipates electric charges that can damage electronic components;  
 Resistance point to point and point to ground between 10<sup>9</sup> and 10<sup>9</sup> Ω.

**NOTE** Please refer to W54 tech sheet for capacity according to configuration. Available on Multi Tool CD.

**NOTE** The 21" deep cabinets are compatible with the 24" WS10/12 tops.  
 The 21" deep cabinets are not compatible with the 30" and 36" WS10/12 tops.  
 The 27" deep cabinets are compatible with the 30" and 36" WS10/12 tops.

Dimensions		Type of Top						
W	D	Acrylic/PVC Plastic Laminated	Painted Steel	Stainless Steel	Laminated Wood	Plastic Laminated	Dissipative	
36"	24"				WS14-3624A	WS16-3624A*		
	30"				WS14-3630A	WS16-3630A*		
48"	24"	WS08-4824A*	WS10-4824	WS12-4824 *	WS14-4824A	WS16-4824A*	WS17-4824A*	
	30"	WS08-4830A*	WS10-4830	WS12-4830 *	WS14-4830A	WS16-4830A	WS17-4830A*	
	36"	WS08-4836A*	WS10-4836	WS12-4836 *	WS14-4836A*	WS16-4836A*	WS17-4836A*	
60"	24"	WS08-6024A*	WS10-6024	WS12-6024 *	WS14-6024A	WS16-6024A	WS17-6024A*	
	30"	WS08-6030A	WS10-6030	WS12-6030 *	WS14-6030A	WS16-6030A	WS17-6030A	
	36"	WS08-6036A*	WS10-6036	WS12-6036 *	WS14-6036A	WS16-6036A	WS17-6036A*	
72"	24"	WS08-7224A	WS10-7224	WS12-7224 *	WS14-7224A	WS16-7224A	WS17-7224A*	
	30"	WS08-7230A	WS10-7230	WS12-7230 *	WS14-7230A	WS16-7230A	WS17-7230A	
	36"	WS08-7236A	WS10-7236	WS12-7236 *	WS14-7236A	WS16-7236A	WS17-7236A	

**NOTE** \*Please check with your customer service representative for lead time.